





TM6100 in dark-stained white oak with Shagreen Grey Oyster leather, wide stiles and one step (OS) sticking.



## Contents

Overview .....	2
Selection Guide .....	4
Architectural Styles .....	8
MDF Door Construction .....	34
Wood Door Construction .....	36
Door Styles .....	38
Design Options .....	98
Wood Species .....	100
Factory Finishing .....	102
Glass and Resin .....	104
Built-In Mirrors .....	106
Metal Panels and Inlays .....	108
Edelman® Leather .....	109
Hinges .....	110
Jambs .....	112
Wood Entry Systems .....	114
Commercial Applications .....	118
Projects .....	120
Recycled Content .....	122
Fire Doors .....	124
Sound Doors .....	126
Design Tools .....	128





## PREMIUM ARCHITECTURAL DOORS

There was a time when doors were appreciated for their architectural value, gracing the openings of homes and embodying the principles of their design periods.

At TruStile, we miss those days. We are committed to partnering with architects, designers, home builders and homeowners to revive the rich tradition of building high-quality, architecturally-correct doors with a range of customization options to fit your preferences and your home's unique character.

FL400 in rift sawn white oak with bevel (BV) sticking; customer-supplied finish and glass



TS3160 common arch pair in MDF with bolection (BM) moulding and raised (A) panel.

## 5 Steps to Designing Your Perfect Door

# 1

### Door Style

From modern flush doors to traditional panel doors, choose from over 400 door styles to match your home's architecture.



# 2

### Material

Select MDF for painted applications or choose from 20 wood species.



MDF



Mahogany

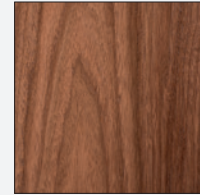

Walnut



White Oak

# 3

### Profile Options

Refine your design with the widest selection of profile options to match your desired style.

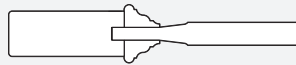

Bolection (BM) moulding with raised (A) panel



Flush construction with 1/4" kerf cut reveal

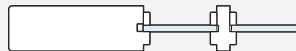

Square stick (SS) sash

# 4

### Decorative Inserts

Consider exchanging a panel for a unique material insert — glass, resin, leather or metal.

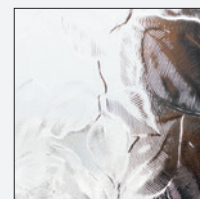

Glass

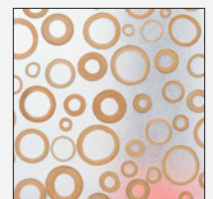

Resin

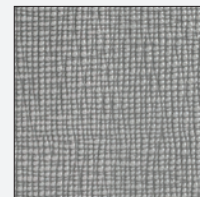

Leather

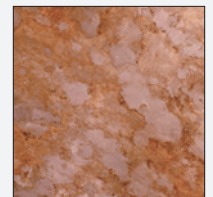

Metal

# 5

### Design Options

Further customize your doors with unique options such as a barn door or common arch pair.

See page 98 for more ideas.

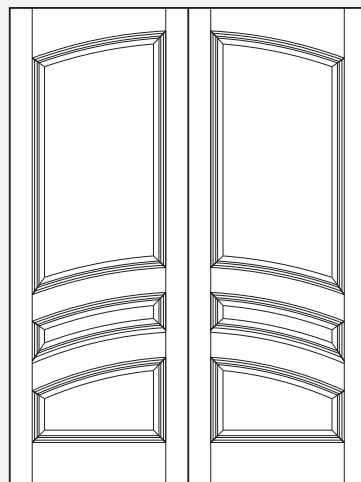

TS3160 Common Arch Pair

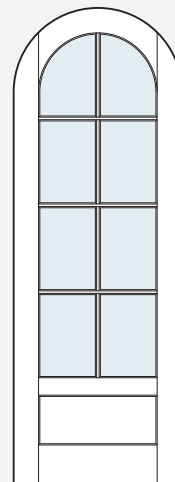

FL841 with radius top

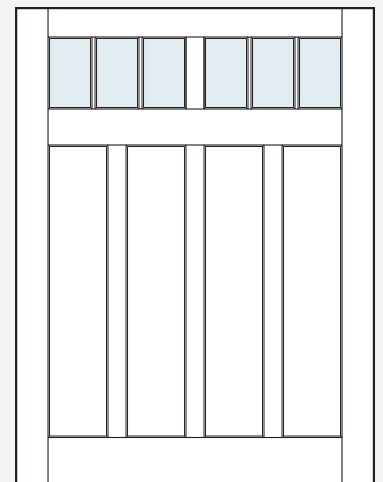

PL243 Barn Door

# Go Beyond the Ordinary

All too often, doors are an overlooked design element — even in high-end custom homes that include an otherwise impressive selection of amenities and upgrades.

Other manufacturers have focused on value-engineering doors, thus diminishing their structural and design integrity. However, the visual impact of high-quality architectural doors is dramatic.



**BEFORE**



**AFTER**

**Before:** (Above) Bath remodel features builder-grade Shaker style doors

**After:** (Right) TM9000 in MDF with inset mirror (left) and TS5000 in MDF with one step (OS) sash and white lami glass.



## Vary Door Size to Create Focal Points

Upon entering this home, visitors are greeted by massive 10-foot-tall doors in luxurious dark walnut. The sheer scale and high-end materials emphasize the importance of the space and create a separation between entertainment spaces and the family's private spaces.

**Left:** TM13340 doors in walnut with Cappuccino finish and frosted glass

## Define Spaces with Materials

Varying materials creates interest while transitioning between spaces.

**Right:** A TM13340 barn door in walnut opens to the family game room

**Below Left:** TM13340 office door in walnut

**Below Right:** TM13340 in painted MDF used in the master bedroom.



## Variations On a Theme

Select a group of door styles that share similar styles, finishes and materials. Here, a new door style is used for guest and children's rooms. The door style relates visually to other doors in the home, but introduces a more casual feel.

**Left:** TM9420 pocket door in MDF with Tuxedo glass

**Below:** TM13340 in painted MDF with frosted glass





TS2020 in walnut and white lami glass.



# FIND YOUR ARCHITECTURAL STYLE

Where do you begin to choose the right door design for your home? TruStile makes the selection process fun and easy. With a range of materials and options for 12 popular architectural styles, TruStile provides the widest range of doors on the market today.

Read on and be inspired with just a few of our tantalizing options for distinctive, remarkable doors.

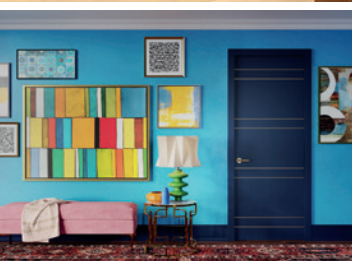

# ART DECO

Art Deco is a design style that emerged in the 1920s and flourished in the 1930s and 1940s. It was a celebration of the machine age and a departure from traditional styles, emphasizing elegance and opulence. Characterized by its bold geometric shapes, rich colors, and luxurious materials, Art Deco reflects a sense of modernity and glamour.



TMB1050 tambour door in  
MDF with half-round profile.  
See additional tambour  
door styles on page 60.

## Configuration Ideas



TS3080



TS3140



FL301

## Suggested Door Styles

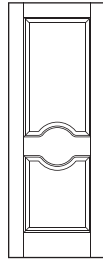

TS2160

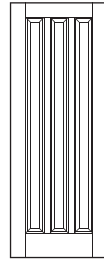

TS3010

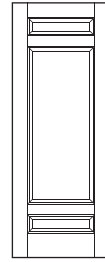

TS3080

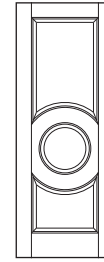

TS3140

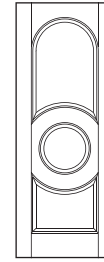

TS3230

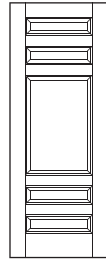

TS5080

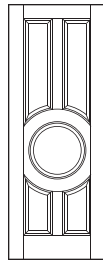

TS5100

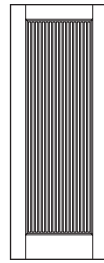

TMB1000

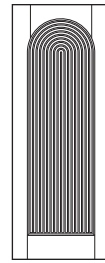

TMB1030

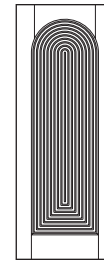

TMB1040

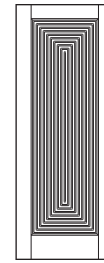

TMB1050

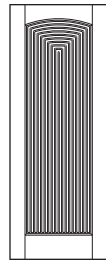

TMB1070



TMB2030

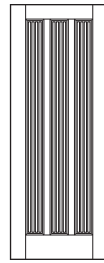

TMB3000

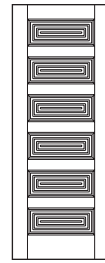

TMB6120

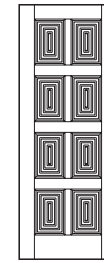

TMB8000

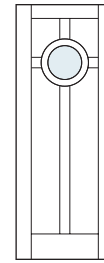

AD1000

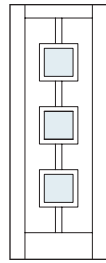

AD1030

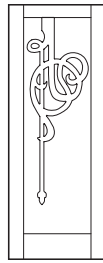

AD1060

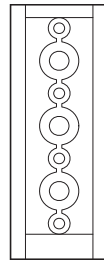

AD1070

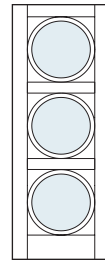

AD3030

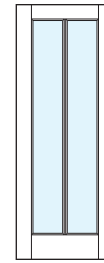

FL200

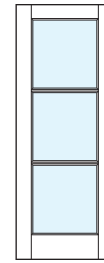

FL300

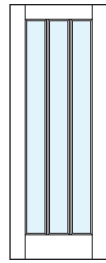

FL301



### More Configuration Ideas

Preview a selection of Art Deco doors in our Door Visualizer tool, where you can try out different materials and profile options.

# COASTAL

Characterized by a light, airy aesthetic that reflects the natural beauty of coastal environments, this style incorporates elements inspired by the sea. Soft blues, whites, and sandy neutrals mix with natural materials like wood, rattan, and linen to create a serene atmosphere reminiscent of beachside living.



TM9110 in MDF with ¼" kerf cut reveals and white lami glass.  
See additional Tru&Modern® stacked rail door styles on page 67

## Configuration Ideas



PL145



TS4140



TMP3000

## Suggested Door Styles

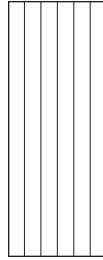

TMP1000



TMP1003



TMP1202

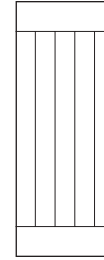

TMP1205

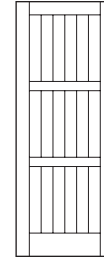

TMP3000

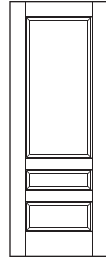

TS3130

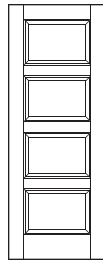

TS4100

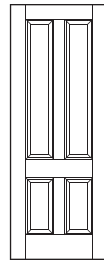

TS4140

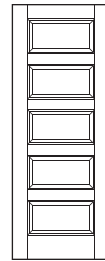

TS5000

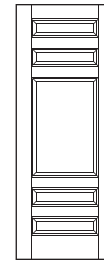

TS5080

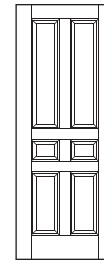

TS6020

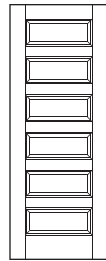

TS6110

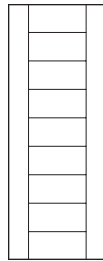

TM9000

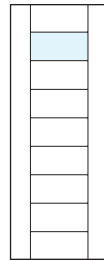

TM9100

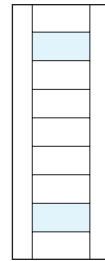

TM9110

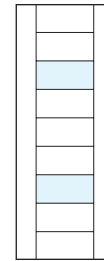

TM9120

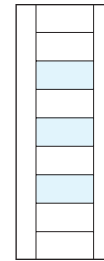

TM9150

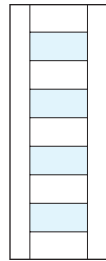

TM9160

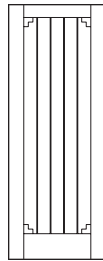

VG1020

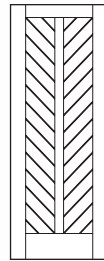

VG2010

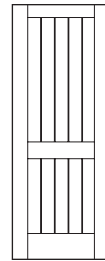

VG2030

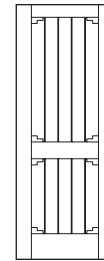

VG2040

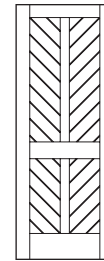

VG4000

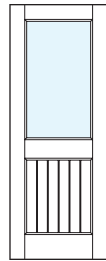

PL145



### More Configuration Ideas

Preview a selection of Coastal doors in our Door Visualizer tool, where you can try out different materials and profile options.

# CRAFTSMAN

The American Craftsman style emerged from the English Arts & Crafts movement of the late 1800s and was a reaction to the overly decorative Victorian era. The style emphasizes simplicity of form, originality and local natural materials. Simplicity and quality workmanship define our Craftsman door collection.



TS3300 in MDF with square stick (SS) sticking and flat (C) panel.

See more TruStile Collection doors on page 42.

### Configuration Ideas



FL900



TS2240



PL244

### Suggested Door Styles

TS2240	TS3070	TS3100	TS3220	TS3250	TS3300
TS4100	TS4230	TS4250	FL400	FL500	FL600
FL900	FL1250	FL1300	FL1310	FL1540	PL133
PL133	PL144	PL243	PL244	PL343	PL344



#### More Configuration Ideas

Preview a selection of Craftsman doors in our Door Visualizer tool, where you can try out different materials and profile options.

# INDUSTRIAL

The Industrial style draws inspiration from warehouses, factories, and other industrial spaces, showcasing raw and utilitarian elements like exposed brick, concrete, and metal — often paired with vintage or repurposed items to create a unique aesthetic. The style emphasizes open layouts, high ceilings, and a neutral color palette, resulting in spaces that feel both functional and stylish.



TMFG1010 in MDF with ¼" kerf cut reveals and white lami glass.

See more Tru&Modern® Flush with Glass doors on page 95

## Configuration Ideas



TMFG2014



TMIR3000



TMIR3100

## Suggested Door Styles

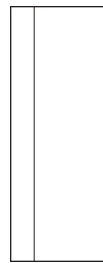

TMIR1001

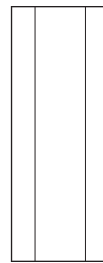

TMIR1002



TMIR2001



TMIR2200

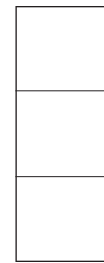

TMIR3000

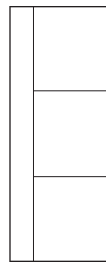

TMIR3001

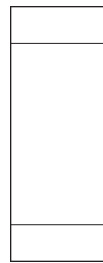

TMIR3080



TMIR3100

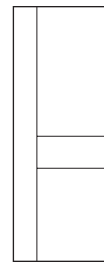

TMIR3101



TMIR4000

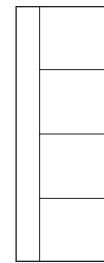

TMIR4001

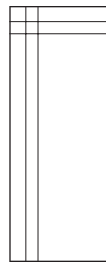

TMIR4020

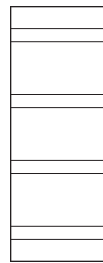

TMIR4200

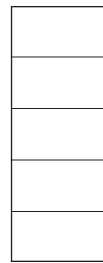

TMIR5000

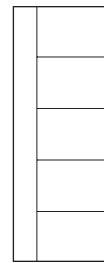

TMIR5001



TMIR5100

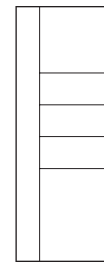

TMIR5101

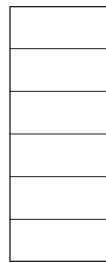

TMIR6000

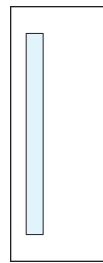

TMFG1010

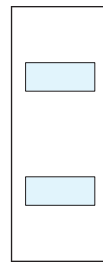

TMFG2011

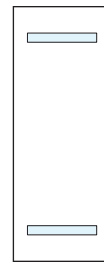

TMFG2015

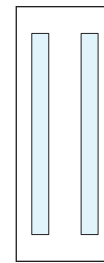

TMFG2017

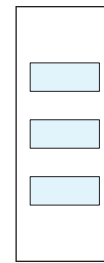

TMFG3011

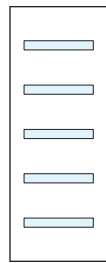

TMFG5010



### More Configuration Ideas

Preview a selection of Industrial doors in our Door Visualizer tool, where you can try out different materials and profile options.

# JAPANDI

Japanese minimalism and Scandinavian functionality mix to create an aesthetic emphasizing simplicity, natural materials, and a serene and harmonious environment. Key features include clean lines, handcrafted elements, and a focus on craftsmanship. Japandi interiors often incorporate plants and natural light to foster a connection with nature while maintaining an inviting atmosphere.

TMF1000 in vertical-grain rift sawn white oak with clear coat finish.

See more flush door styles on page 80.



## Configuration Ideas



FL450



TMP1003



TMUN12000

## Suggested Door Styles



TMF1000  
Horizontal Grain



TMF1000  
Vertical Grain

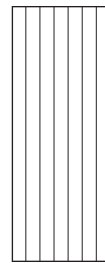

TMP1000

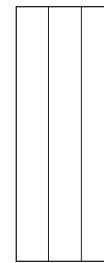

TMP1003

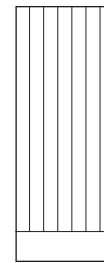

TMP1100

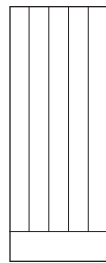

TMP1105

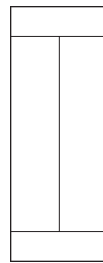

TMP1202

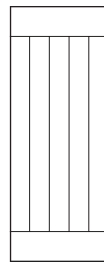

TMP1205

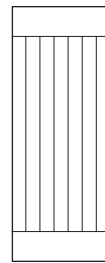

TMP2000



TMUN1000



TMUN2000

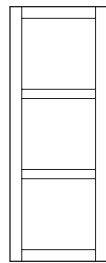

TMUN3000

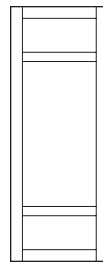

TMUN3080

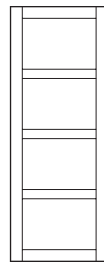

TMUN4000

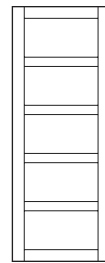

TMUN5000

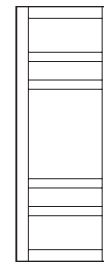

TMUN5080



TMUN6000

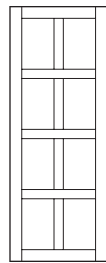

TMUN8000

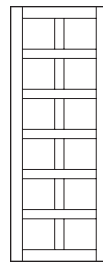

TMUN120000

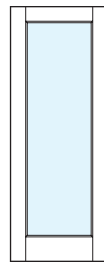

FL100

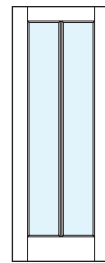

FL200

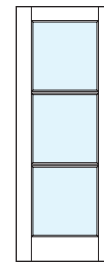

FL300

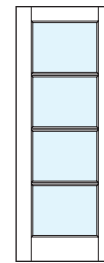

FL400

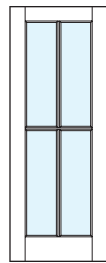

FL450



### More Configuration Ideas

Preview a selection of Japandi doors in our Door Visualizer tool, where you can try out different materials and profile options.

# MAXIMALIST

Maximalist design is characterized by an abundance of colors, patterns, textures, and decorative elements. It embraces a “more is more” philosophy, encouraging the use of bold and eclectic combinations. This style often features layered furnishings, vibrant artwork, and collections of vintage and contemporary pieces, creating a visually stimulating environment.



TMIR4200 in MDF with ½" brushed light brass metal inlays.  
See more Tru&Modern® Infinite Rail door styles on page 89.

## Configuration Ideas

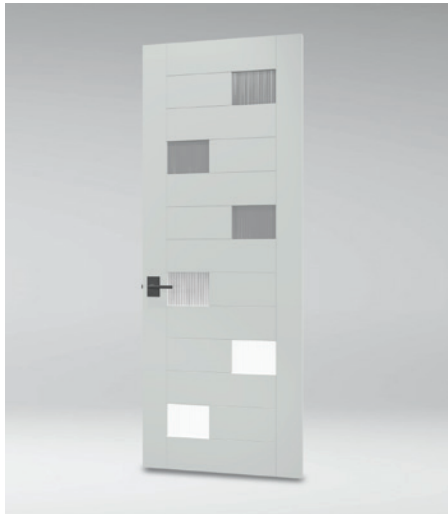

TM13420



TMIR1014



TS7020

## Suggested Door Styles

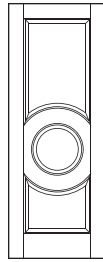

TS3140

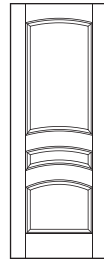

TS3160

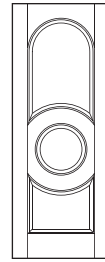

TS3230

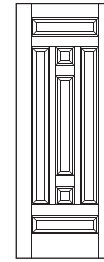

TS7010

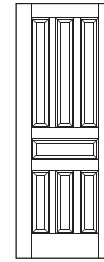

TS7020

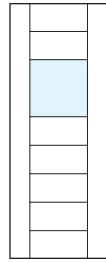

TM9220

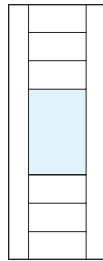

TM9240

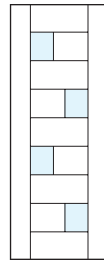

TM9420

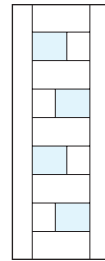

TM9430

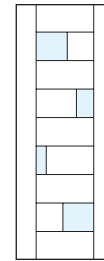

TM9440

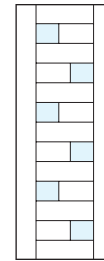

TM13420

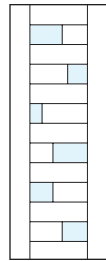

TM13440

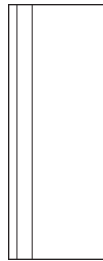

TMIR1012

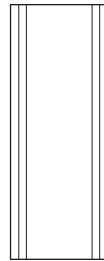

TMIR1014

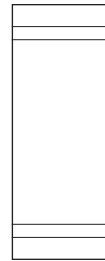

TMIR2200

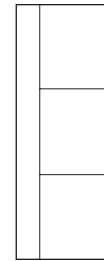

TMIR3001



TMIR4000



TMIR4002

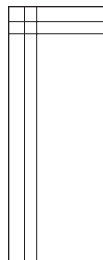

TMIR4020

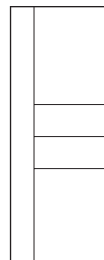

TMIR4101

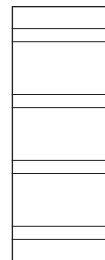

TMIR4200

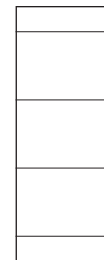

TMIR5080



TMIR5100

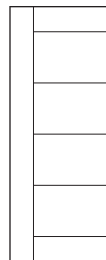

TMIR6081



### More Configuration Ideas

Preview a selection of Maximalist doors in our Door Visualizer tool, where you can try out different materials and profile options.

# MEDITERRANEAN

The Mediterranean style is characterized by its warm, inviting atmosphere and a blend of rustic and elegant elements. Combined with a color palette inspired by the sea, sun and coastal landscapes, it evokes a relaxed, leisurely lifestyle. Key elements include terracotta tiles, wooden beams, and wrought iron details, which create a sense of authenticity and charm.



VG3030 in cherry with Nutmeg finish, square stick (SS) sticking and standard v-groove panels.  
See more V-Groove series doors on page 58.

## Configuration Ideas



FL830



TS2070



VG1010

## Suggested Door Styles

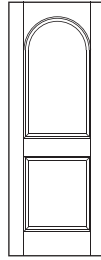

TS2070

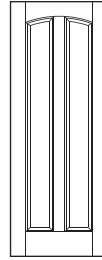

TS2130

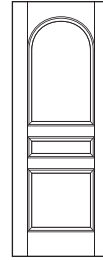

TS3180

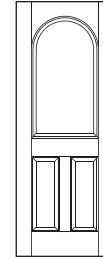

TS3260

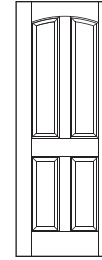

TS4050

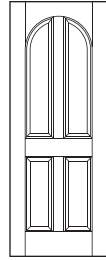

TS4070

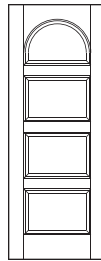

TS4310

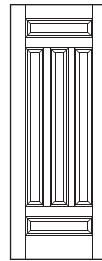

TS5030

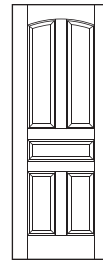

TS5050

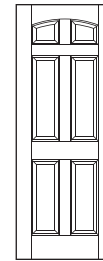

TS6070

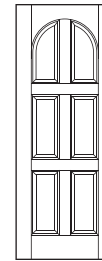

TS6090

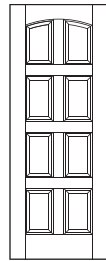

TS8020

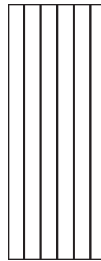

VG1000

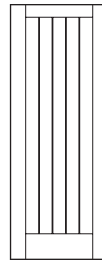

VG1010

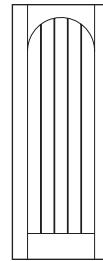

VG1040

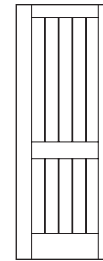

VG2030

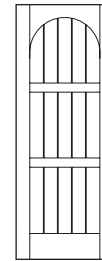

VG3030

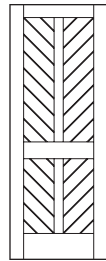

VG4000

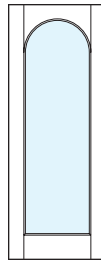

FL103

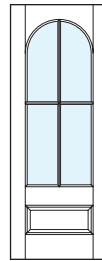

FL455

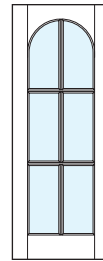

FL609

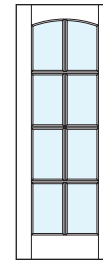

FL830

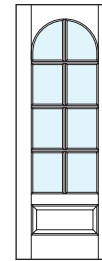

FL841

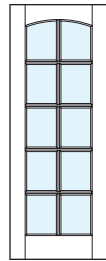

FL1020



### More Configuration Ideas

Preview a selection of Mediterranean doors in our Door Visualizer tool, where you can try out different materials and profile options.

# MODERN FARMHOUSE

Traditional charm mixed with a contemporary aesthetic, create a harmonious blend of comfort and sophistication that feels both stylish and lived-in. There is a focus on simplicity and functionality, demonstrated in open floor plans, natural materials and a pale color palette. Key elements include exposed wooden beams, shiplap walls, and vintage-inspired furnishings that evoke a sense of nostalgia.

FL616 in MDF with square stick (SS) sticking, flat (C) panel, and frosted glass.

See more French Lite series doors on page 50.



## Configuration Ideas



TMP3000



TS4100



FL400

## Suggested Door Styles

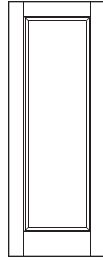

TS1000

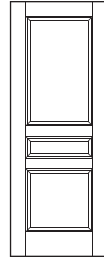

TS3070

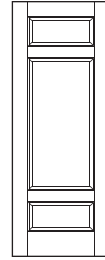

TS3080

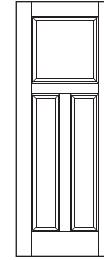

TS3300

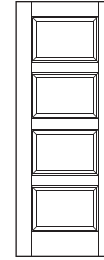

TS4100

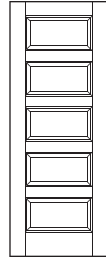

TS5000

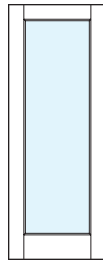

FL100

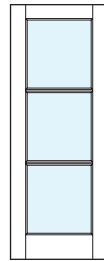

FL300

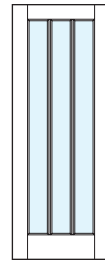

FL301

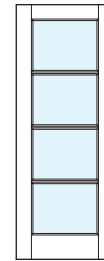

FL400

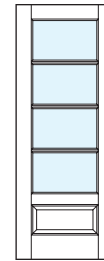

FL401

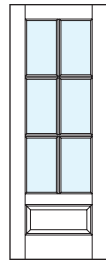

FL616

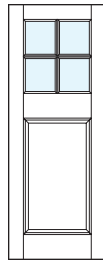

PL134

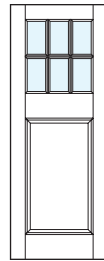

PL136

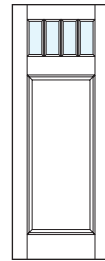

PL144

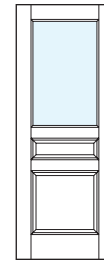

PL220

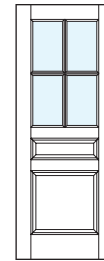

PL224

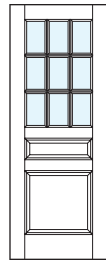

PL229

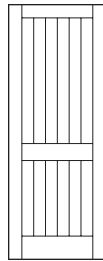

VG2030

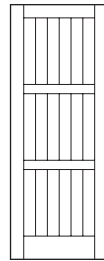

VG3000

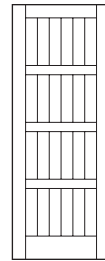

VG4000



TMUN3080

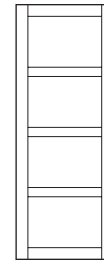

TMUN4000

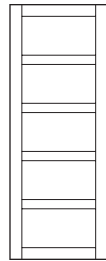

TMUN5000



### More Configuration Ideas

Preview a selection of Modern Farmhouse doors in our Door Visualizer tool, where you can try out different materials and profile options.

# MOUNTAIN MODERN

A contemporary aesthetics blends with rustic elements, drawing inspiration from the natural beauty of mountainous landscapes. This design approach emphasizes open spaces, large windows, and natural light, creating a seamless connection between indoor and outdoor environments. Key features include a color palette inspired by the surrounding nature and use of local stone and wood.

TMP1003 in mahogany with a ¼" kerf cut reveal and clear finish. See more Tru&Modern® Plank door styles on page 85.



## Configuration Ideas



TM9400



TMF1000



TMIR6080

## Suggested Door Styles

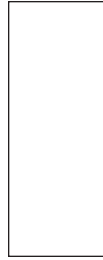

TMF1000

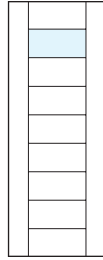

TM9100

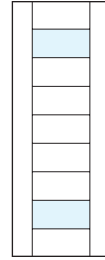

TM9110

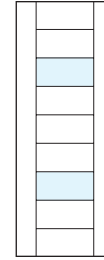

TM9120

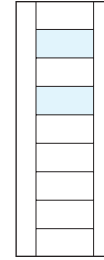

TM9130

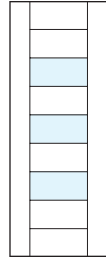

TM9150

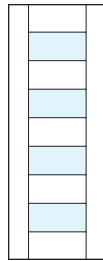

TM9160

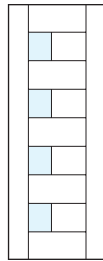

TM9400

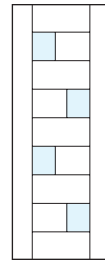

TM9420

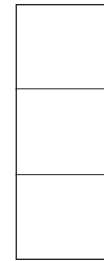

TMIR3000



TMIR3080

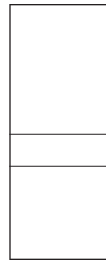

TMIR3100



TMIR4000

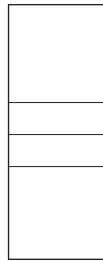

TMIR4100

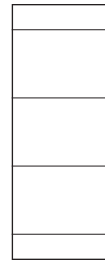

TMIR5080



TMIR6000

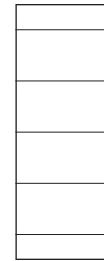

TMIR6080



TMIR6100



TMP1002

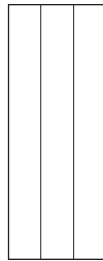

TMP1003



TMP1202

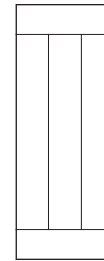

TMP1203

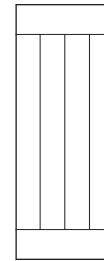

TMP1204

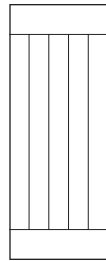

TMP1205

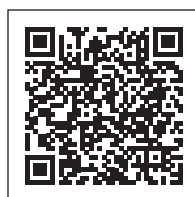

### Configuration Ideas

Preview a selection of Mountain Modern doors in our Door Visualizer tool, where you can try out different materials and profile options.

# NORDIC

Nordic design, often referred to as Scandinavian design, emphasizes simplicity, functionality and light colors, which traditionally helped brighten a home during dark winter days. It includes elements of hygge, promoting comfort and coziness through soft furnishings, layered textures, and inviting decor.



TMIR10000 in horizontal-grain select alder with bleached finish and ¼" kerf cut reveals.

See more Tru&Modern® Infinite Rail doors on page 89.

### Configuration Ideas



TMIR6000



TMFG6010



TMP1204

### Suggested Door Styles

TMF1000 Horizontal Grain	TMF1000 Vertical Grain	TMP1000	TMP1002	TMP1003	TMP1004
TMP1010	TMP1102	TMP1103	TMP1104	TMP1105	TMP1202
TMP1203	TMP1204	TMP2000	TMP2030	TMP3000	TMP4000
TMIR6000	TMIR9000	TMIR11000	TMFG4010	TMFG4011	TMFG6010



#### More Configuration Ideas

Preview a selection of Nordic doors in our Door Visualizer tool, where you can try out different materials and profile options.

# TRADITIONAL

Traditional design reflects a sense of heritage and a connection to the past, making it a popular choice for those who appreciate familiarity, craftsmanship and classic elegance. The style draws on historical elements and cultural influences to create a classic and timeless aesthetic — often incorporating rich colors, ornate details, and a sense of symmetry and balance.



TS5060 in MDF with bevel (BV) sticking and raised (A) panel.  
See more TruStile Collection doors on page 42.

## Configuration Ideas



PL109



TS3050



TS5030

## Suggested Door Styles

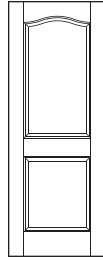

TS2040

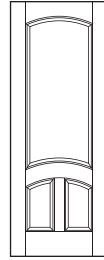

TS3040

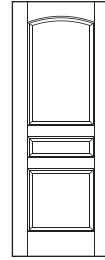

TS3050

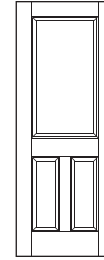

TS3060

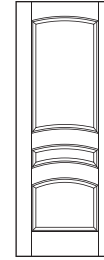

TS3160

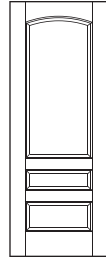

TS3360

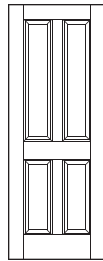

TS4000

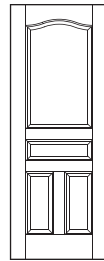

TS4020

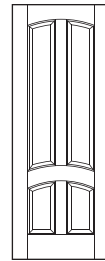

TS4030

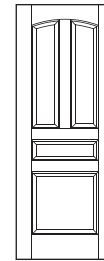

TS4040

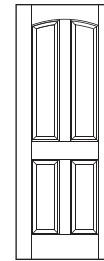

TS4050

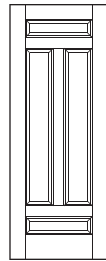

TS4290

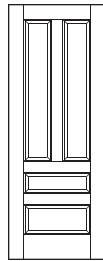

TS4300

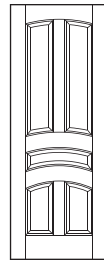

TS5020

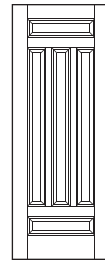

TS5030

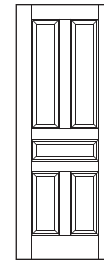

TS5060

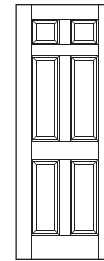

TS6000

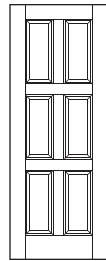

TS6080

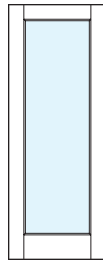

FL100

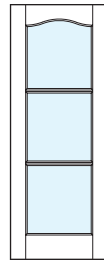

FL304

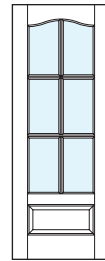

FL617

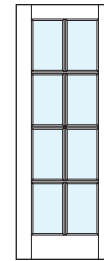

FL800

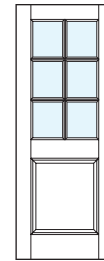

PL106

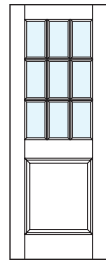

PL109

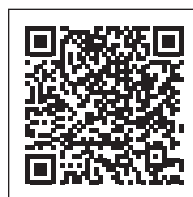

### More Configuration Ideas

Preview a selection of Traditional doors in our Door Visualizer tool, where you can try out different materials and profile options.

# TRANSITIONAL

Transitional design is a harmonious balance between traditional and contemporary aesthetics that is timeless, stylish and livable. It emphasizes comfort and functionality while incorporating classic elements with modern touches. This style features use of soft color palettes, clean lines, and a mix of textures, allowing for a sophisticated yet inviting atmosphere.

TS1000 in MDF with miracle (MR) tiered moulding and flat (C) panel. See more tiered moulding options on page 47.



## Configuration Ideas



FL100



TS2060



TS4100

## Suggested Door Styles

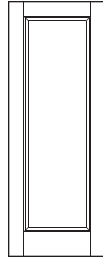

TS1000

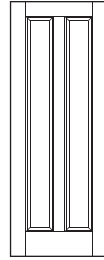

TS2000

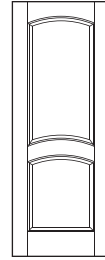

TS2050

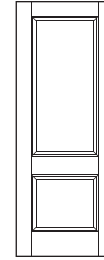

TS2060

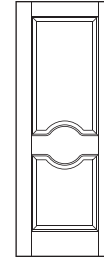

TS2160

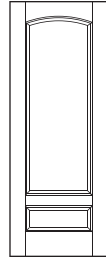

TS2230

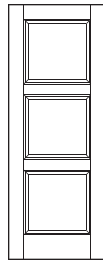

TS3000

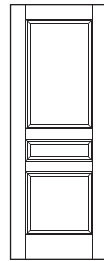

TS3070

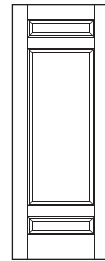

TS3080

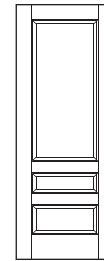

TS3130

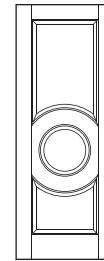

TS3140

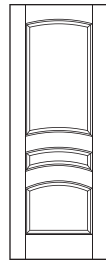

TS3160

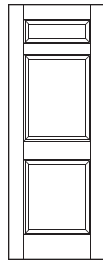

TS3250

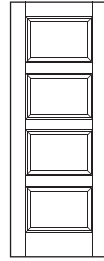

TS4100

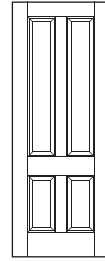

TS4140

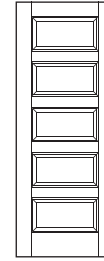

TS5000

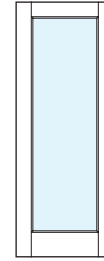

FL100

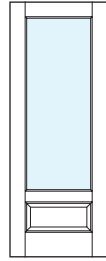

FL110

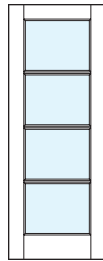

FL400

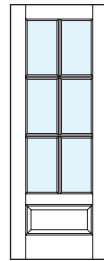

FL616

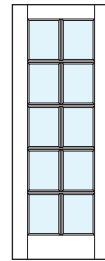

FL1000

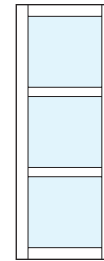

TMUN3000

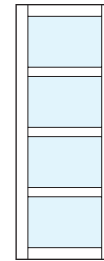

TMUN4000

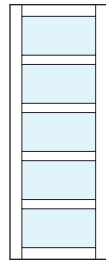

TMUN5000



### More Configuration Ideas

Preview a selection of Transitional doors in our Door Visualizer tool, where you can try out different materials and profile options.

# MDF Door Construction

TruStile pioneered the use of medium density fiberboard (MDF) as a preferred material for painted door applications, realizing its many advantages over alternative materials like natural wood. Since we introduced our MDF doors to the market, we've seen many impersonators.

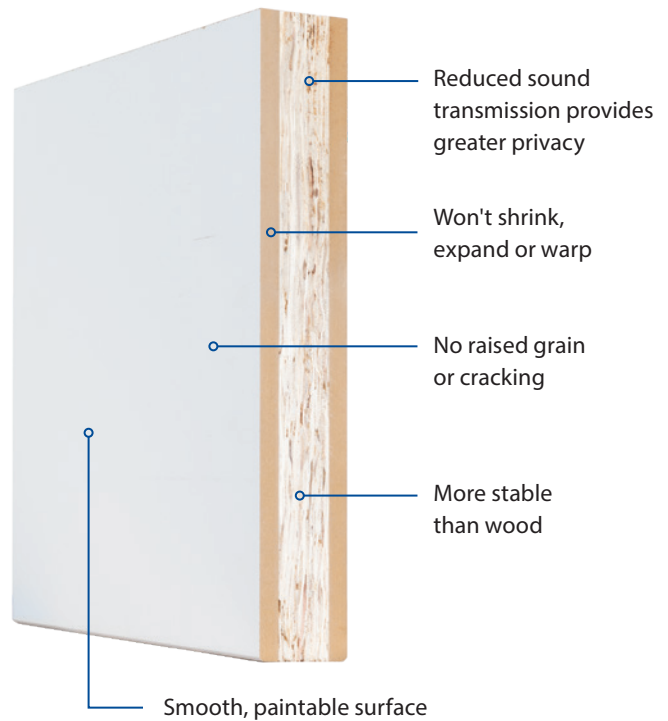
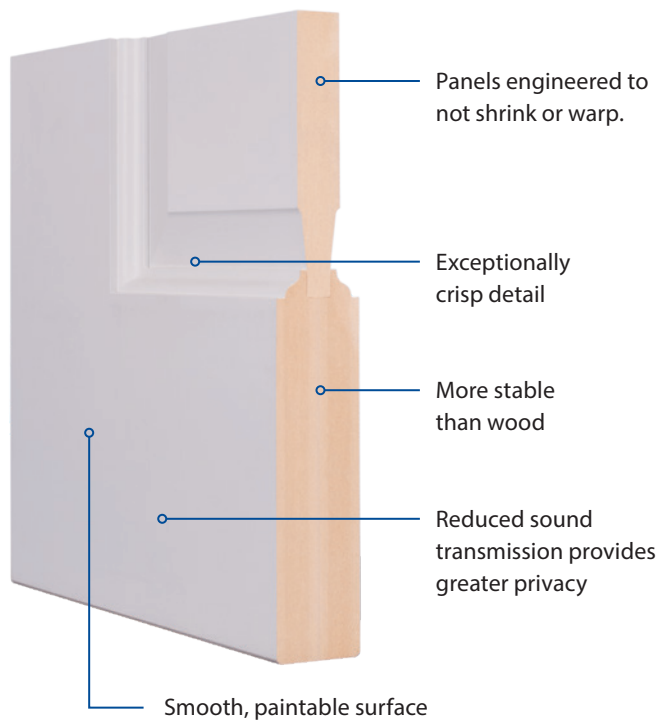

## Stile & Rail Construction

- Made to order and built to any size and style.
- Built with genuine stile and rail construction — never routed or stamped with poplar Wedge Edge® provides a secure mount for hardware.
- Made with solid, super-refined MDF that provides a smoother painting surface than pine, poplar or lower-grade MDF alternatives.
- Engineered for maximum stability and durability — won't shrink, expand or warp when exposed to environment.
- More affordable than wood doors.

## Flush Door Construction

- Made to order and built to any size and style.
- Laminated Strand Lumber (LSL) core with poplar Wedge Edge® provides a secure mount for hardware.
- Made with solid, super-refined MDF that provides a smoother painting surface than pine, poplar or lower-grade MDF alternatives.
- Engineered for maximum stability and durability — won't shrink, expand or warp when exposed to environment.
- More affordable than wood doors.



Pair of TS6110 doors in MDF with Roman Ogee (OG) sticking and Flat (C) panel

# Natural Wood Door Construction

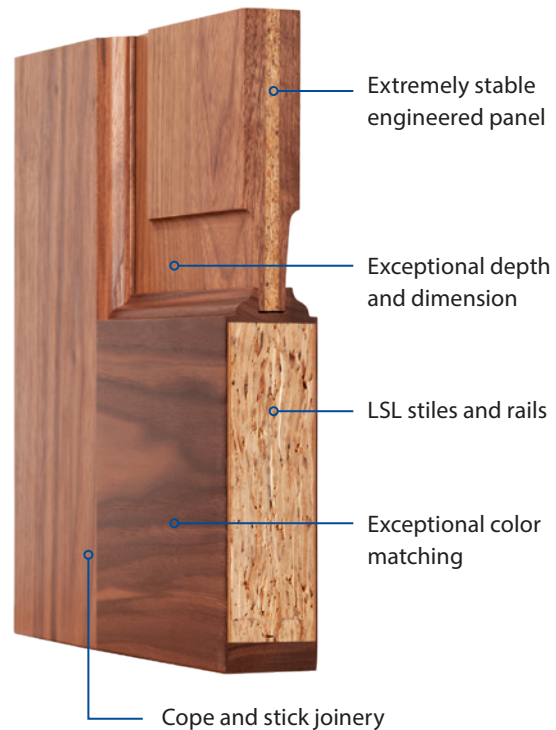
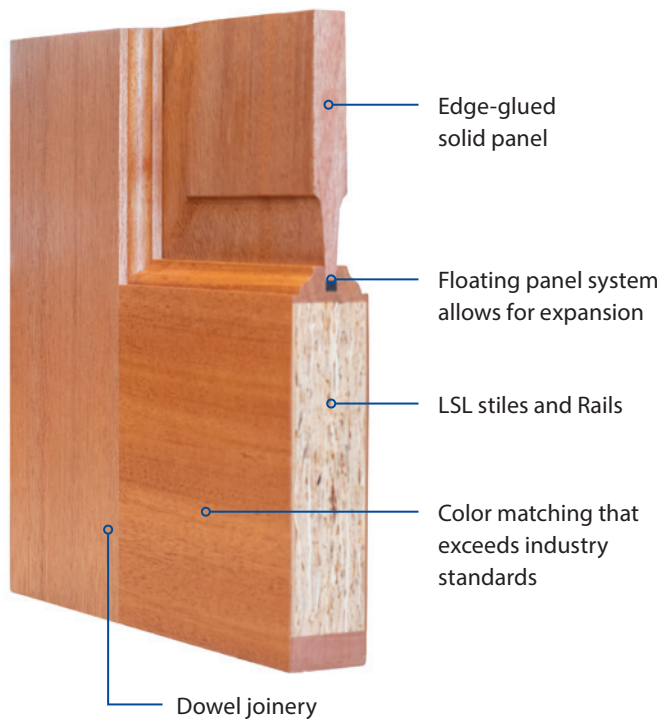

## TruStile Wood Doors

### STILE & RAIL CONSTRUCTION

TruStile natural wood doors are the ultimate expression of luxury for today's interiors. Each door is made to order and meticulously constructed with a blend of traditional and state-of-the-art materials and methods.

- Stiles and rails are faced with  $\frac{1}{16}$ " flitch veneers, hand-selected for a consistent appearance that enhances the natural beauty of wood.
- Raised panels are built of solid lumber staves, hand-sorted for a well matched, premium appearance.
- Stile and rail construction, combined with cope and stick jointery, allows for design flexibility and provides precise, architecturally correct details.
- Solid lumber edges, laminated strand lumber (LSL) core and dowel joints provide exceptional strength, durability and stability.
- Our floating panel system utilizes flexible cushions to secure all panel edges, accommodating the natural expansion and contraction of wood while preventing shifting and rattles.

## TruStile Reserve® Wood Doors

### STILE & RAIL CONSTRUCTION

Designed to the highest level of quality, TruStile Reserve Wood Doors are the ultimate expression of luxury for today's interiors and made to order using the latest technological advances combined with meticulous handcrafted detail.

- All door styles, panel options, and sticking profiles, and are customizable to meet specific project applications.
- Stiles and rails are faced with  $\frac{1}{16}$ " flitch veneers, hand-selected for a consistent appearance that enhances the natural beauty of wood.
- Upgraded raised panels are built with hand-sorted lumber staves and a composite lumber core, providing a stable panel that doesn't expand or contract like solid wood panels.
- Stile and rail construction, combined with cope and stick jointery, allows for design flexibility and provides precise, architecturally accurate details.
- Solid lumber edges, laminated strand lumber (LSL) core and dowel joints provide exceptional strength, durability and stability.

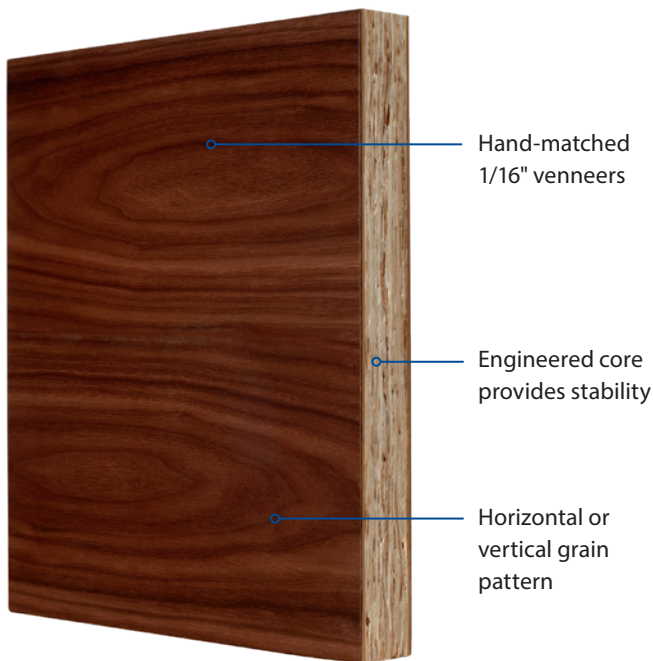

## TruStile Reserve® Wood Doors

### FLUSH CONSTRUCTION

TruStile has developed the first high-end flush doors designed specifically for the residential market. Our highly engineered core provides stability for the door while a continuous, matching hardwood edge on all four sides provides a seamless and beautiful appearance.

- Hand selected  $\frac{1}{16}$ " flitch veneers are precision matched by wood species to optimize the beautiful natural wood aesthetics across every door.
- On door pairs, veneers are matched across the faces of both doors to ensure a consistent look across the opening.
- Available in both horizontal and vertical grain orientations, or a combination of both with our sketch face designs.
- TruStile Reserve flush doors are engineered with a laminated strand lumber (LSL) core, HDF cross bands and solid lumber edges to provide exceptional strength, durability and maximum stability.



TMF1000 door in horizontal-grain walnut with Nutmeg finish



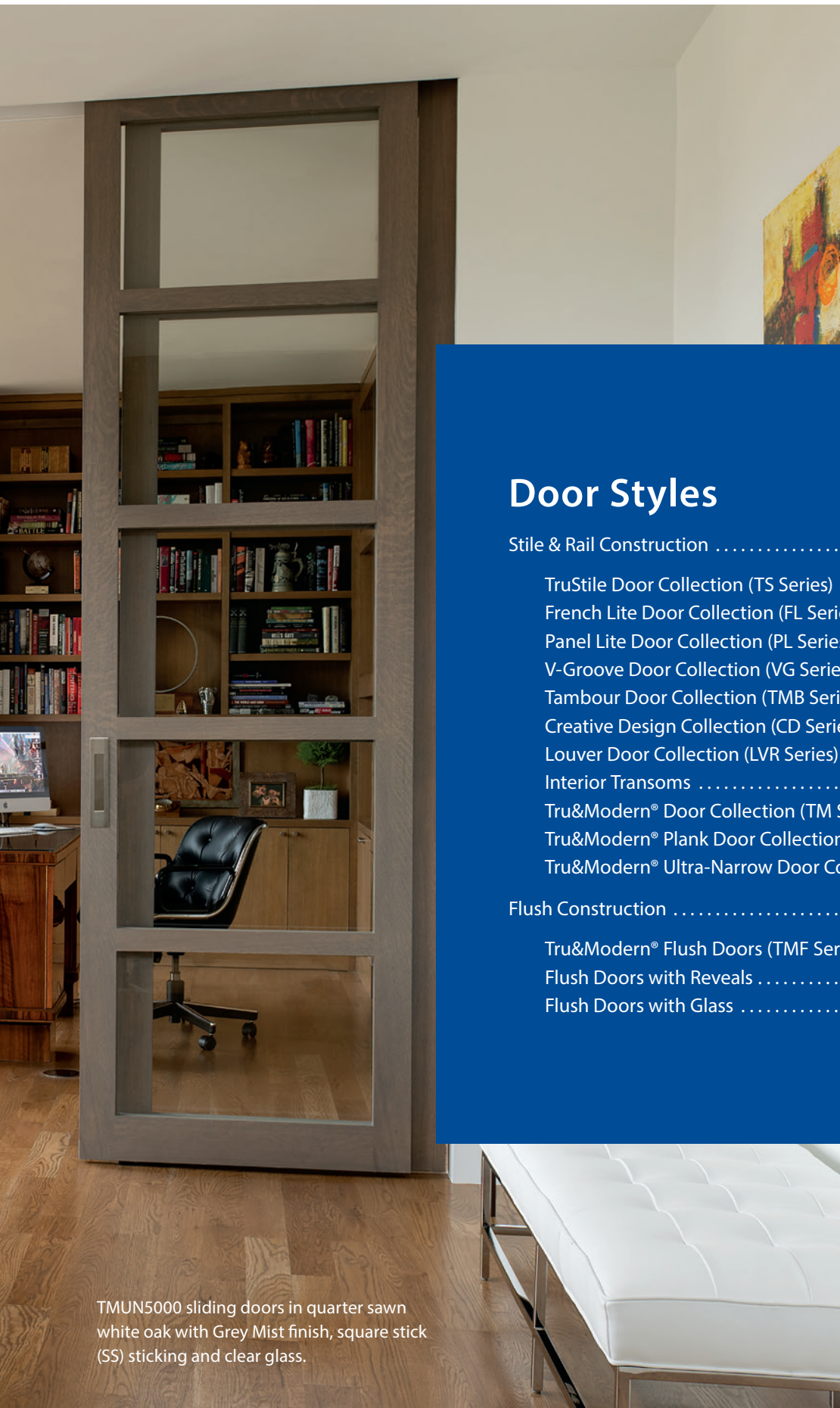

TMUN5000 sliding doors in quarter sawn white oak with Grey Mist finish, square stick (SS) sticking and clear glass.

## Door Styles

Stile & Rail Construction .....	40
TruStile Door Collection (TS Series) .....	42
French Lite Door Collection (FL Series) .....	50
Panel Lite Door Collection (PL Series) .....	56
V-Groove Door Collection (VG Series) .....	58
Tambour Door Collection (TMB Series) .....	60
Creative Design Collection (CD Series) .....	60
Louver Door Collection (LVR Series) .....	62
Interior Transoms .....	64
Tru&Modern® Door Collection (TM Series) .....	66
Tru&Modern® Plank Door Collection (TMP Series) .....	74
Tru&Modern® Ultra-Narrow Door Collection (TMUN Series) .....	76
Flush Construction .....	78
Tru&Modern® Flush Doors (TMF Series) .....	80
Flush Doors with Reveals .....	84
Flush Doors with Glass .....	94

# STILE & RAIL CONSTRUCTION

TruStile's authentic stile and rail doors offer crisp details and design flexibility, which can't be replicated in routed or stamped doors. Each door is made to order with perfectly proportioned components, individually crafted to ensure every door is architecturally correct, regardless of size.

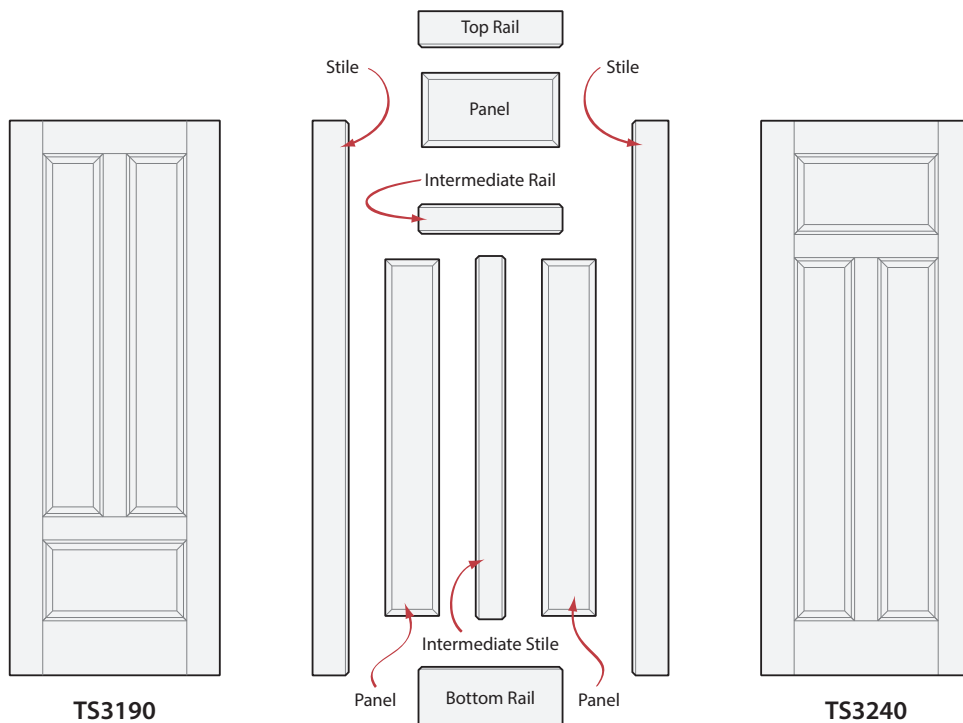

## All Doors Are Not Created Equal

The figure illustrates the timeless advantage of TruStile's authentic stile and rail construction. All door components can be customized and combined to create the door style you desire, each with crisp, architecturally-correct details.





TS8000 in rift sawn white oak with bevel (BV) sticking and customer-supplied glass and finish.

# TruStile Door Collection (TS Series)







Our TruStile door collection features over 100 architecturally-correct panel door styles from one- to nine-panel configurations. Each door is built with genuine stile and rail construction and is never routed or stamped. As a result, our panel doors have crisp, clean lines and unmatched detail.



TS3070 doors in MDF with bolection (BM) moulding and flat (C) panel

## TruStile Collection Door Styles

										
TS1000	TS1010	TS1030	TS1050	TS2000	TS2010	TS2020	TS2030	TS2040	TS2050	TS2060
										
										
TS2070	TS2080	TS2090	TS2130	TS2160	TS2170	TS2180	TS2190	TS2200	TS2210	TS2220
										
										
TS2230	TS2240	TS2250	TS2260	TS3000	TS3010	TS3020	TS3030	TS3040	TS3050	TS3060
										
										
TS3070	TS3080	TS3090	TS3100	TS3110	TS3120	TS3130	TS3140	TS3150	TS3160	TS3170
										

-  Arch-top option available
-  Radius-top option available
-  Common-arch pair option available
-  Bi-fold closet option available
-  Available as a fire-rated door\*
-  Available in MDF only

\* Contact TruStile to confirm exact fire ratings and sizes available

# TruStile Collection Door Styles

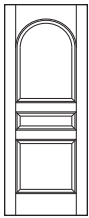

TS3180

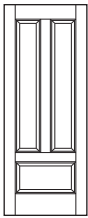

TS3190

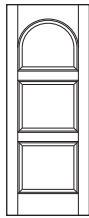

TS3210

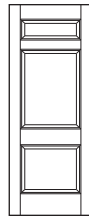

TS3220

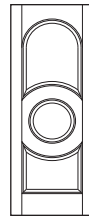

TS3230

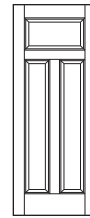

TS3240

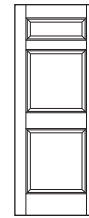

TS3250



TS3260



TS3270

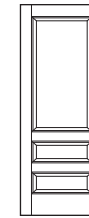

TS3280

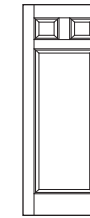

TS3290

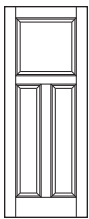

TS3300

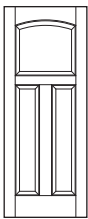

TS3310

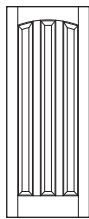

TS3320

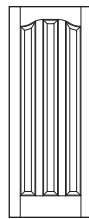

TS3330

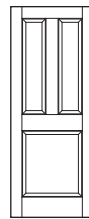

TS3340

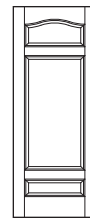

TS3350

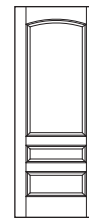

TS3360

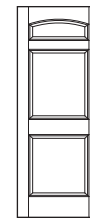

TS3370



TS4000



TS4010

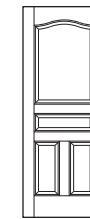

TS4020

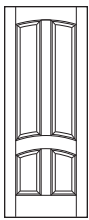

TS4030

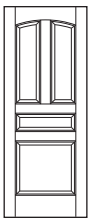

TS4040

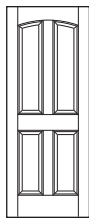

TS4050

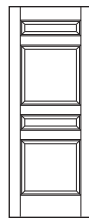

TS4060

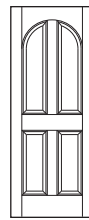

TS4070

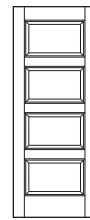

TS4100

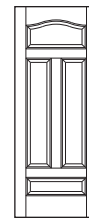

TS4110



TS4120



TS4130



TS4140



TS4150

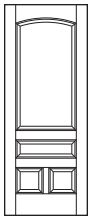

TS4170

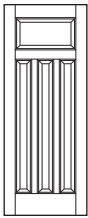

TS4190

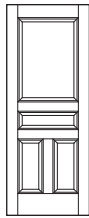

TS4200

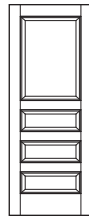

TS4210

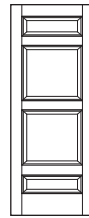

TS4220

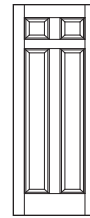

TS4230



TS4240

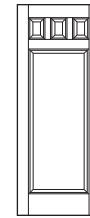

TS4250

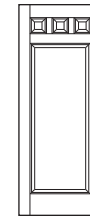

TS4260

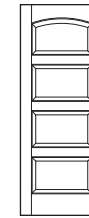



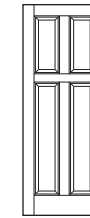







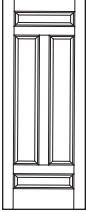
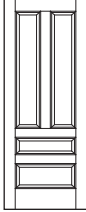
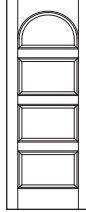
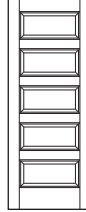
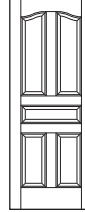
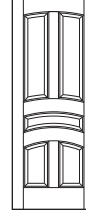
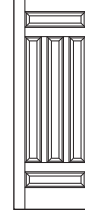

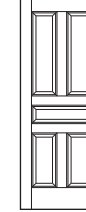
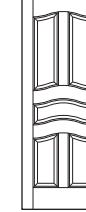











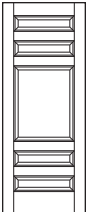
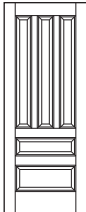
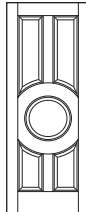
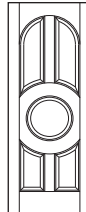
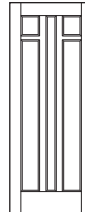
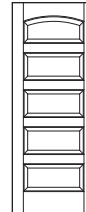



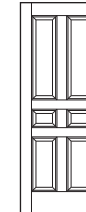
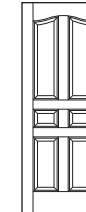











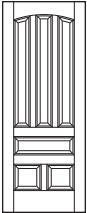
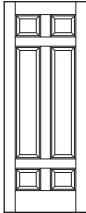
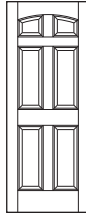
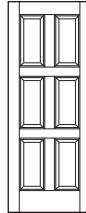
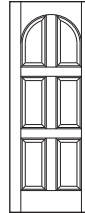
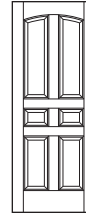
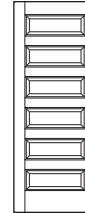

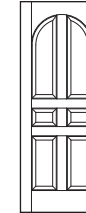









TS4270

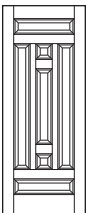
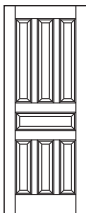
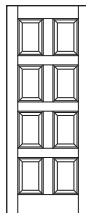
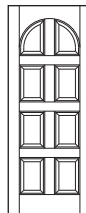
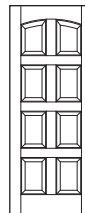
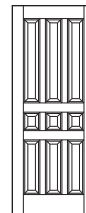







TS4280



## TruStile Collection Door Styles

										
TS4290	TS4300	TS4310	TS5000	TS5010	TS5020	TS5030	TS5040	TS5050	TS5060	TS5070
										
										
TS5080	TS5090	TS5100	TS5110	TS5120	TS5130	TS5140	TS6000	TS6010	TS6020	TS6030
										
										
TS6040	TS6050	TS6070	TS6080	TS6090	TS6100	TS6110	TS6120	TS6130	TS6140	TS7000
										
										
TS7010	TS7020	TS8000	TS8010	TS8020	TS9000	TS9010				
										

-  Arch-top option available
-  Radius-top option available
-  Common-arch pair option available
-  Bi-fold closet option available
-  Available as a fire-rated door\*
-  Available in MDF only

\* Contact TruStile to confirm exact fire ratings and sizes available

## Profile Options

A door profile refers to the joint where the sticking and panel come together. You can achieve distinct looks by selecting different sticking and panel combinations. With so many combinations to choose from, we're confident you'll find the perfect profile for your project. If not, we can partner with you to create a custom profile.

### Sticking and Moulding Options

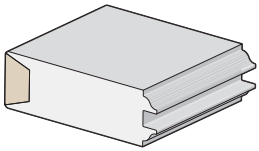

Roman Ogee (OG) Sticking

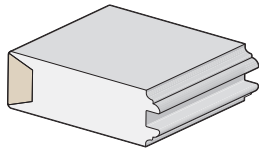

Cove & Bead (CB) Sticking

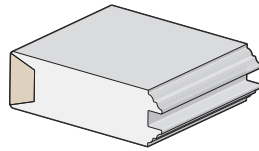

Traditional (TR) Sticking

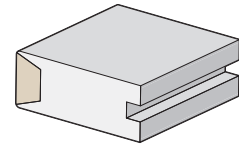

Square Stick (SS) Sticking

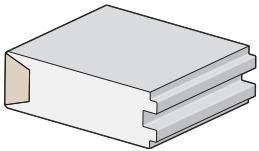

One Step (OS) Sticking

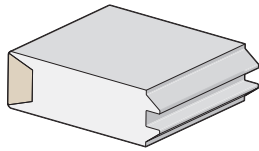

Bevel (BV) Sticking

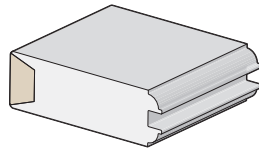

Quarter Bead (QB) Sticking

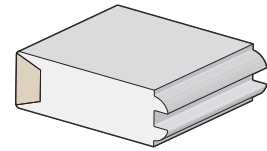

Quarter Round (QR) Sticking

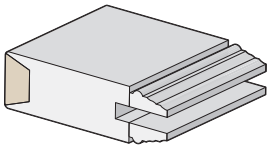

Low Profile Bolection (LP) Moulding

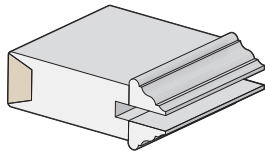

Bolection (BM) Moulding

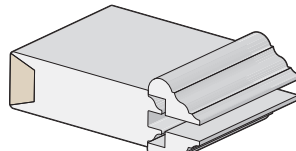

Big Bolection (BBM) Moulding

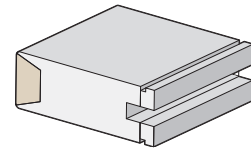

Quirk (QM) Moulding

### Panel Options

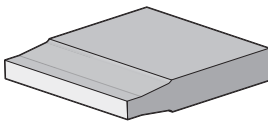

Raised (A) Panel

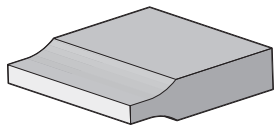

Scoop (B) Panel

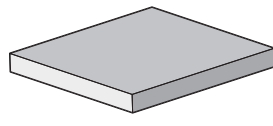

Flat (C) Panel

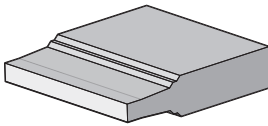

Double Hip (D) Panel

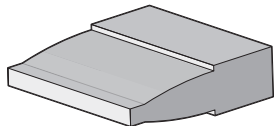

Senior Raised (E) Panel

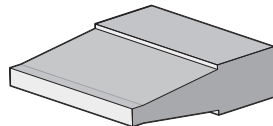

Senior Bevel (F) Panel



TS2060 in MDF with Linea (LN) moulding and flat (C) panel

### Tiered Mouldings Options

Create a sophisticated look from even the simplest door. Tiered mouldings are available for door styles with rectangular panels and look best on styles with fewer panels.

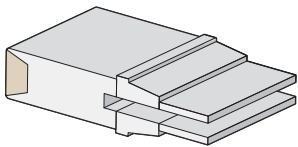

Avant (AV)

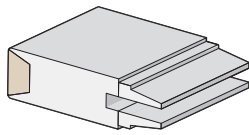

Avant Low Profile (AVLP)

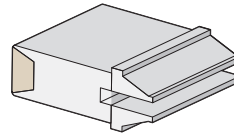

Evoke (EV)

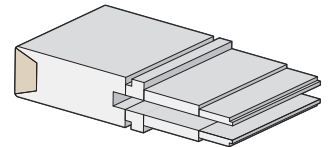

Empire (EM)

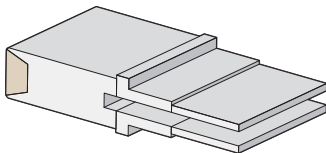

Linea (LN)

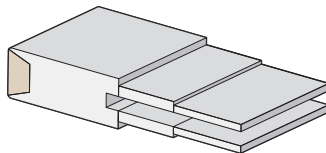

Linea Low Profile (LNLP)

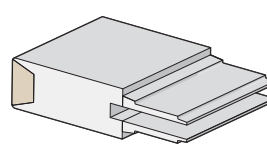

Miracle (MR)

## Senior Flat (H) Panel

Available on stile & rail wood doors

Based on a common custom design request, TruStile has developed a new, unique thick flat panel design in wood that provides a modern look with  $\frac{1}{4}$ " gap created between the panel and surrounding stiles and rails. This nearly flush panel option brings a sophisticated, modern look to wood stile and rail doors.

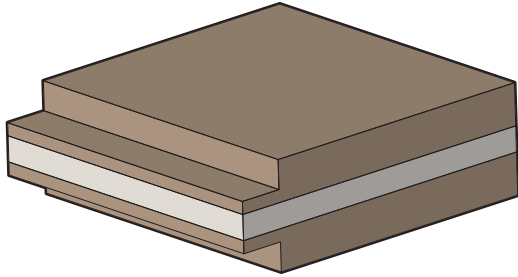

1- $\frac{3}{4}$ " Senior Flat (H) panel  
Available in wood only

## AVAILABLE SIZES

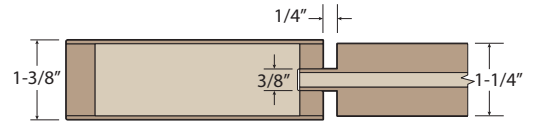

1- $\frac{3}{8}$ " Profile with Square Stick (SS) sticking and Senior Flat (H) panel

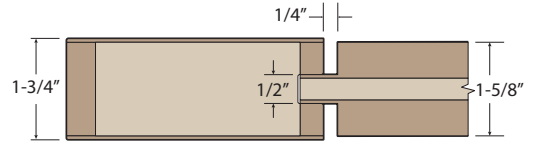

1- $\frac{3}{4}$ " Profile with Square Stick (SS) sticking and Senior Flat (H) panel

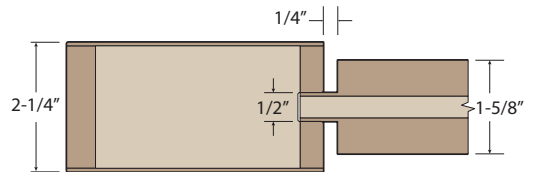

2- $\frac{1}{4}$ " Profile with Square Stick (SS) sticking and Senior Flat (H) panel



TS4100 in MDF S4S two-tiered applied moulding and flat (C) panel. Shown with drywall return jamb

## S4S Applied Moulding

*Configurable profiles create a look that is uniquely your own*

We are pleased to introduce a configurable "Surface 4 Sides" (S4S) applied moulding design. Choose one or two tiers of moulding in a variety of customizable dimensions.

### SINGLE TIER EXAMPLES

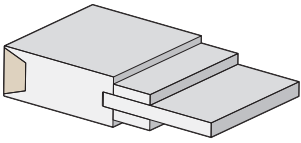

**Single tier look**

Tier one size  $1\text{-}\frac{1}{2}\text{'' W} \times \frac{3}{8}\text{'' H}$

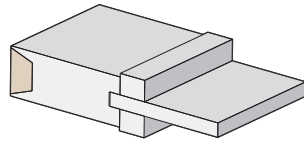

**Bold frame look**

Tier one size  $1\text{'' W} \times \frac{3}{4}\text{'' H}$

### DOUBLE TIER EXAMPLES

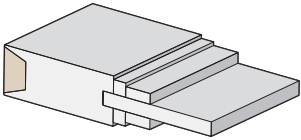

**Simple tiered look (shown right)**

Tier one size  $\frac{1}{2}\text{'' W} \times \frac{1}{2}\text{'' H}$   
 Tier two size  $1\text{'' W} \times \frac{3}{8}\text{'' H}$

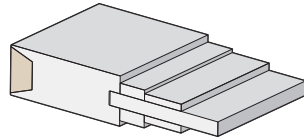

**Mid-size tiered look**

Tier one size  $1\text{'' W} \times \frac{3}{8}\text{'' H}$   
 Tier two size  $1\text{-}\frac{1}{2}\text{'' W} \times \frac{1}{4}\text{'' H}$

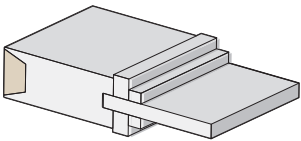

**Simple step look**

Tier one size  $\frac{3}{4}\text{'' W} \times \frac{3}{4}\text{'' H}$   
 Tier two size  $\frac{1}{2}\text{'' W} \times \frac{3}{8}\text{'' H}$

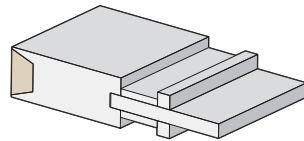

**Jumbo quirk look**

Tier one size  $1\text{-}\frac{1}{2}\text{'' W} \times \frac{1}{4}\text{'' H}$   
 Tier two size  $\frac{1}{2}\text{'' W} \times \frac{1}{2}\text{'' H}$

S4S Mouldings are available in both MDF and wood and can be configured with the following dimensions

**Width:**  $\frac{1}{4}\text{''}, \frac{1}{2}\text{''}, \frac{3}{4}\text{''}, 1\text{''}, 1\text{-}\frac{1}{2}\text{''}$     **Height**  $\frac{1}{4}\text{''}, \frac{3}{8}\text{''}, \frac{1}{2}\text{''}, \frac{5}{8}\text{''}, \frac{3}{4}\text{''}, \frac{7}{8}\text{''}$



TS4100 in MDF S4S two-tiered applied moulding and flat (C) panel. Shown with drywall return jamb.



### Get this look

Recreate the look of the S4S applied moulding on the door above by selecting two mouldings with the following measurements.





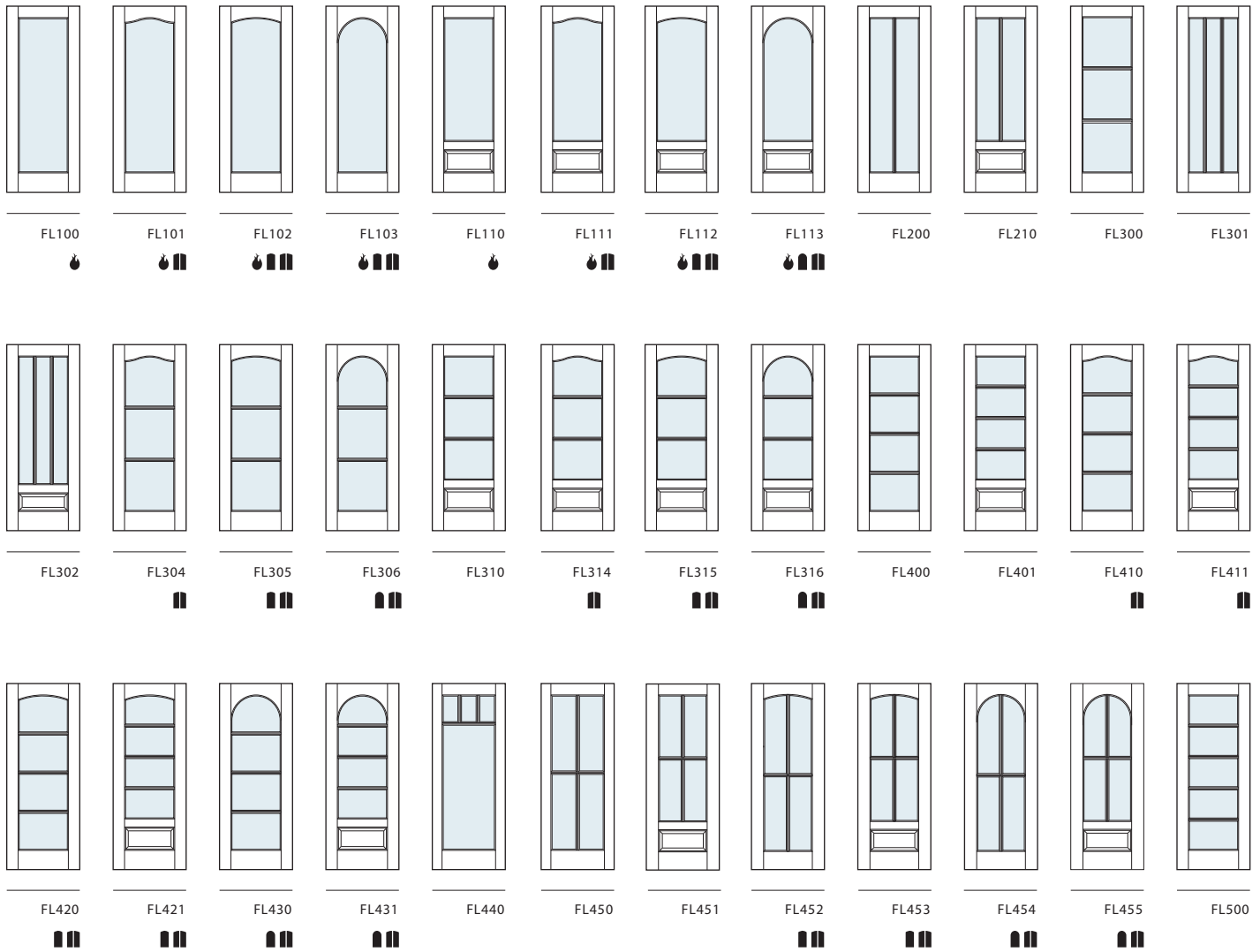

First tier size  $\frac{1}{2}\text{'' W} \times \frac{1}{2}\text{'' H}$   
 Second tier size  $1\text{'' W} \times \frac{3}{8}\text{'' H}$

# French Lite Door Collection (FL Series)

Our French Lite door collection offers 100 classic glass door designs from one- to 18-lite configurations. Our French Doors are crafted with true divided lites. Each individual piece of glass is hand-inserted for maximum architectural detail.

## French Lite Door Styles



-  Arch-top option available
-  Radius-top option available
-  Common-arch pair option available
-  Bi-fold closet option available
-  Available as a fire-rated door\*
-  Available in MDF only

\* Contact TruStile to confirm exact fire ratings and sizes available







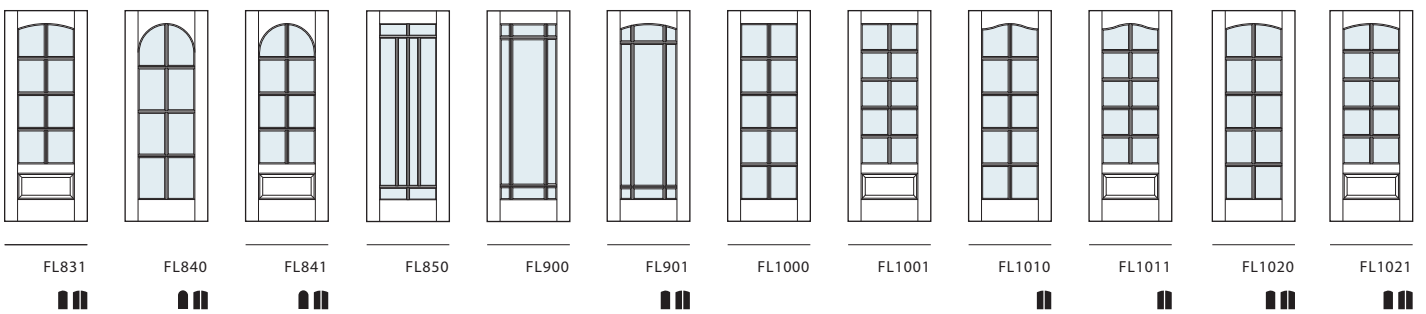
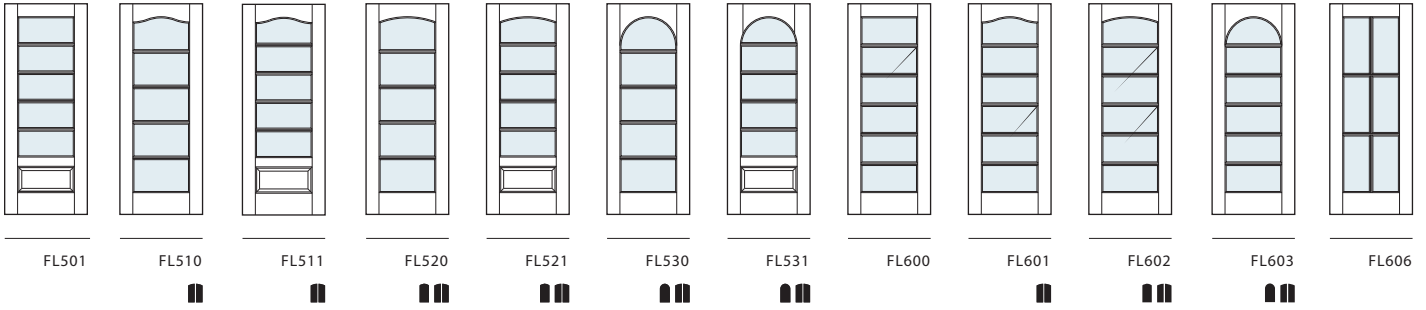

FL300 in MDF with one step (OS) sash and bevel glass.

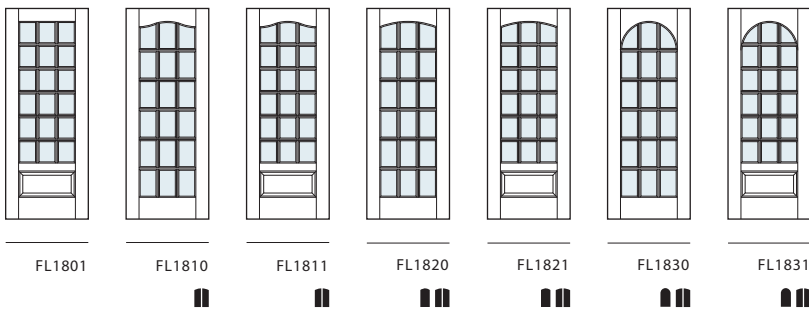
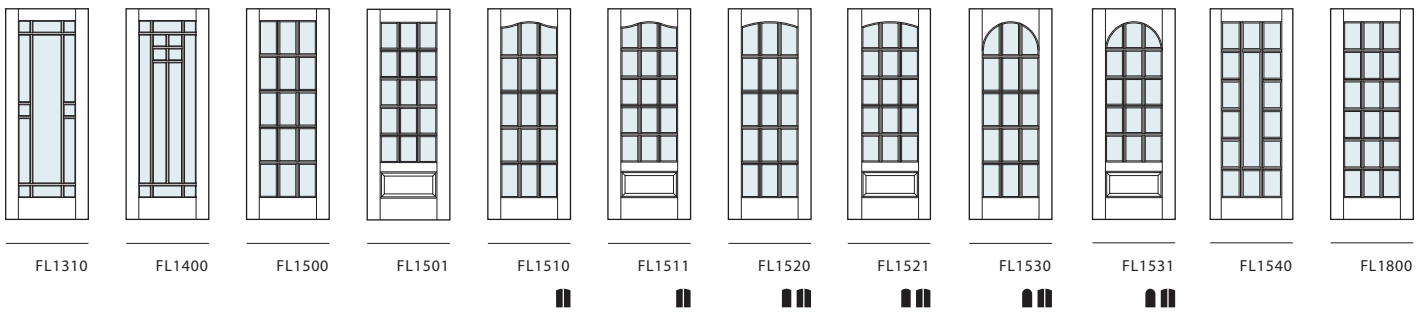
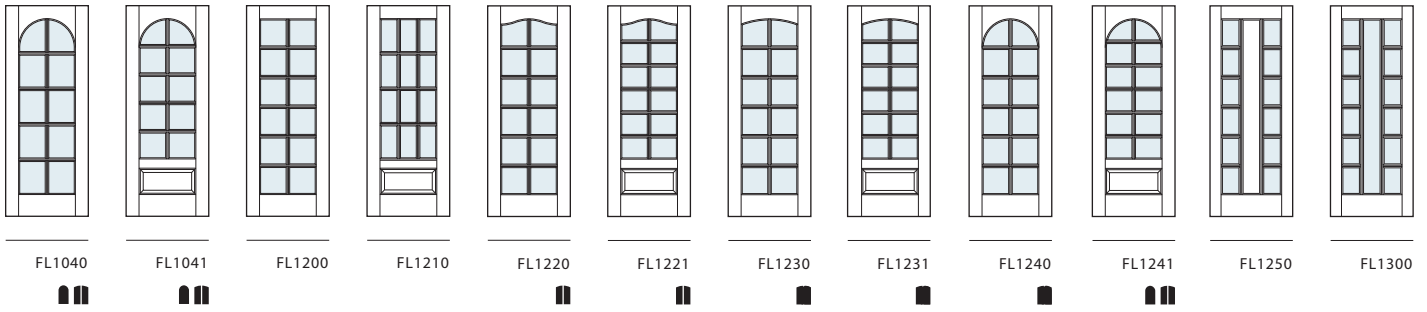
## French Lite Door Styles



## French Lite Door Styles



-  Arch-top option available
-  Bi-fold closet option available
-  Radius-top option available
-  Available as a fire-rated door\*
-  Common-arch pair option available
-  Available in MDF only

\* Contact TruStile to confirm exact fire ratings and sizes available



Pair of FL400 doors in rift sawn white oak with bevel (BV) sticking and custom glass.

## Profile Options

The following sash and compression fit options are available to match our panel door profiles.

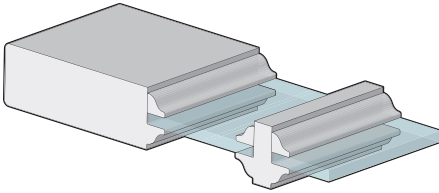

Reverse Roman Ogee (OG) Sash

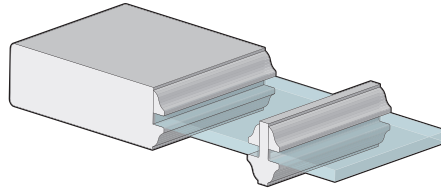

Narrow Reverse Roman Ogee (OG) Sash\*

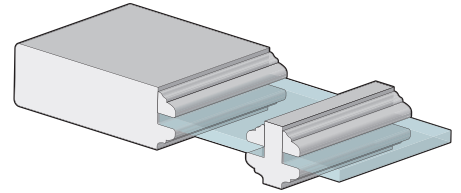

Cove & Bead (CB) Sash

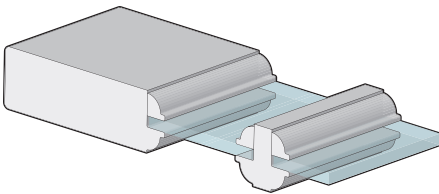

Quarter Bead (QB) Sash

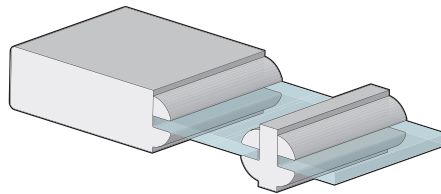

Quarter Round (QR) Sash

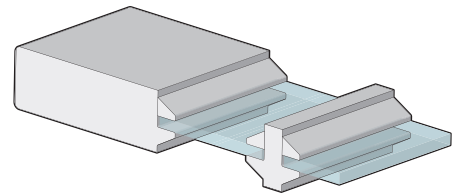

Bevel (BV) Sash

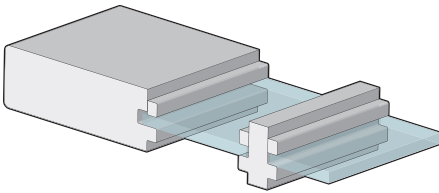

Square Stick (SS) Sash

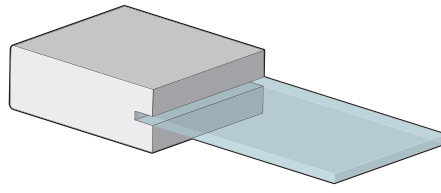

Square Stick (SS) Compression Fit\*\*

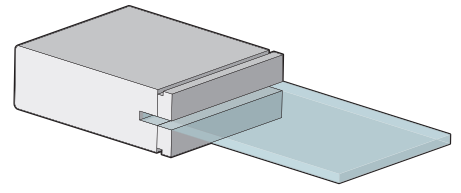

Quirk Moulding (QM) Compression Fit\*\*

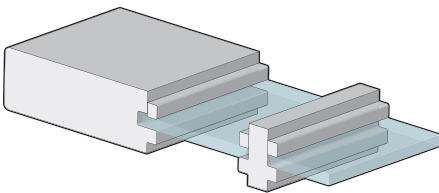

One Step (OS) Sash

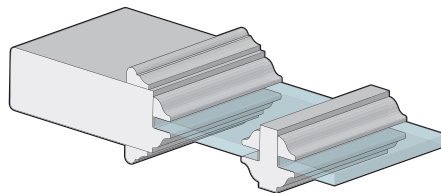

Applied Raised Moulding (ARM)

\* *Optional 7/8" narrow muntin bars available only on interior doors with 1/4" glass.*

\*\* *On compression fit doors, glass cannot be replaced if broken.*

## Panel Lite Door Collection (PL Series)







Our Panel Lite door collection combines raised and flat panels with glass lites, giving you the best of both styles. A popular selection for pantries, bathrooms and entries, panel lite doors can be used for both interior and exterior applications.



PL243 in cherry with clear coat finish,  
one step (OS) sticking and flat (C) panel.

## Panel Lite Door Styles



-  Arch-top option available
-  Radius-top option available
-  Common-arch pair option available
-  Bi-fold closet option available
-  Available as a fire-rated door\*
-  Available in MDF only

\* Contact TruStile to confirm exact fire ratings and sizes available

## V-Groove Door Collection (VG Series)

Our V-groove (VG series) door collection features a tongue-and-groove look that emulates plank doors. Each door is built with genuine stile and rail construction to ensure greater performance than plank doors.



VG4010 barn door in wire-brushed white oak, finished by customer.

## V-Groove Door Styles

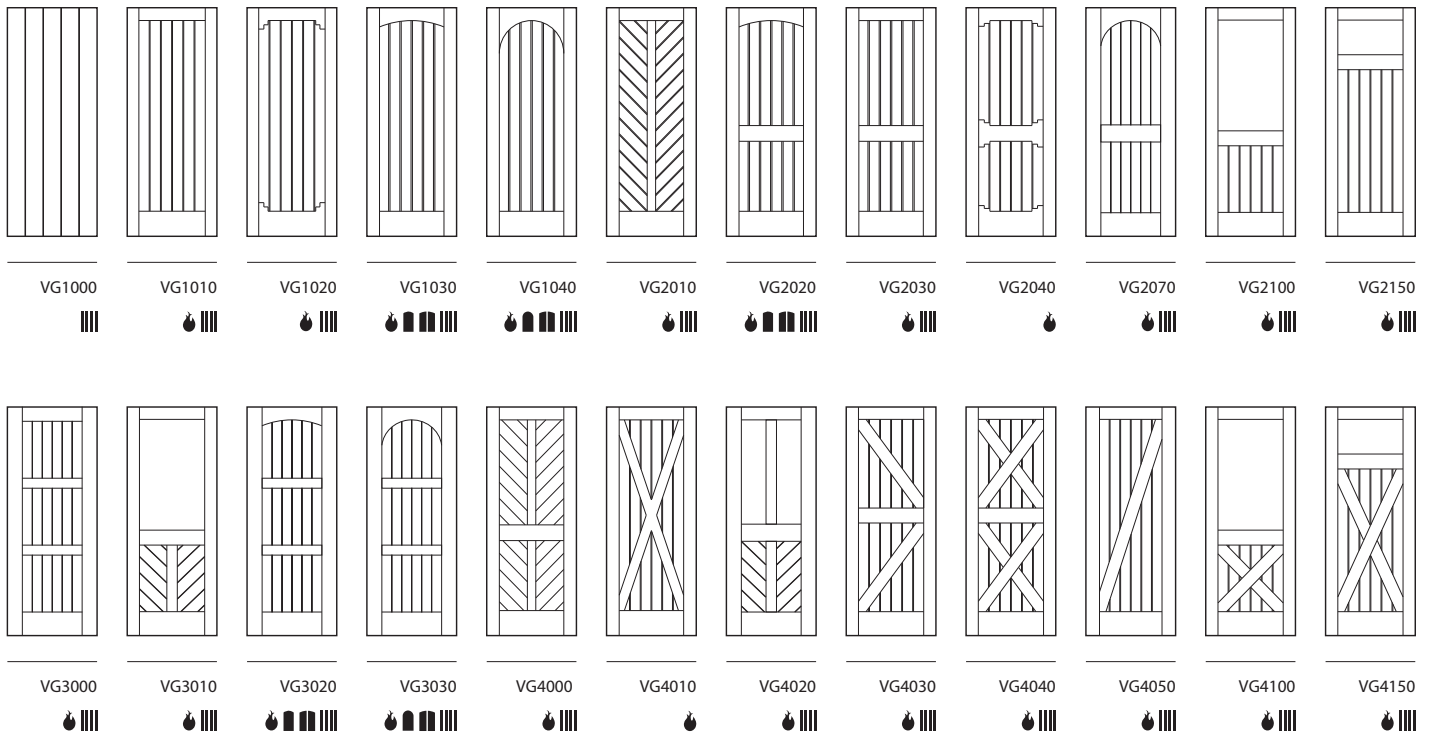

## Plank Door Profiles (VG1000)

Plank-style V-Groove doors are available with standard, wide and extra-wide plank spacing and the following profiles:

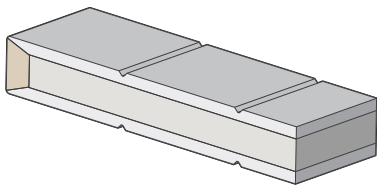

Standard V-Groove Profile

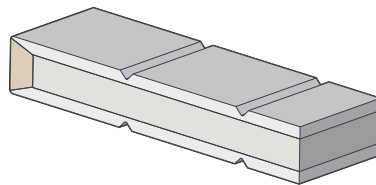

Standard V-Groove Profile

## V-Groove Profiles

Standard V-Groove doors come with one of the following profiles:

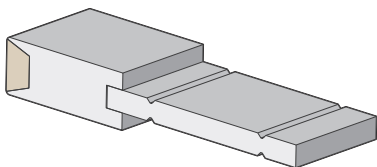

Standard V-Groove Profile

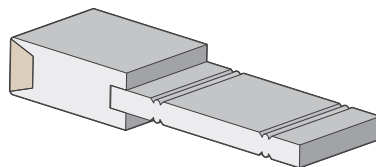

Beaded V-Groove Profile

- Arch-top option available
- Radius-top option available
- Common-arch pair option available
- Bi-fold closet option available
- Available as a fire-rated door\*
- Available in MDF only

\* Contact TruStile to confirm exact fire ratings and sizes available



TMB1050 door in MDF with quarter bead (QB) sticking and half-round tambour profile.

## Tambour Door Collection (TMB Series)

Our Tambour door collection combines stile and rail construction with state-of-the-art CNC routing technology to create a uniquely contemporary look. Combine these doors with other styles for design interest and visual variety.

### Tambour Profile Options

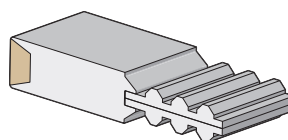

Bevel Tambour Profile

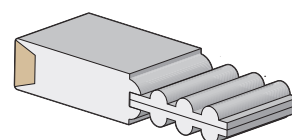

Half-Round Tambour Profile

## Creative Design Collection (CD Series)

The Creative Design collection features an eclectic mix of custom styles from our design team. These exclusive TruStile designs fulfill a variety of architectural styles and are perfect for creating a dramatic visual impact. TruStile's Creative Design Collection proves that doors can be just as exciting as other home design elements.







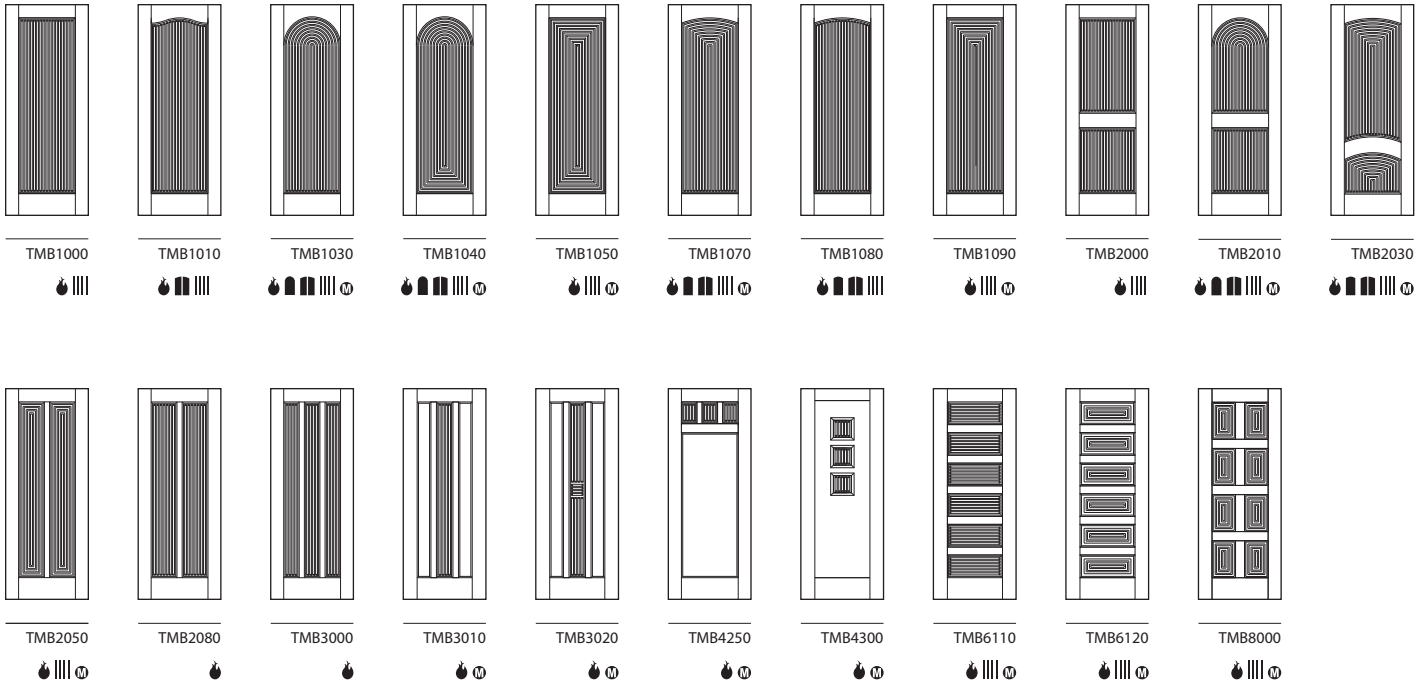

AD3030 in MDF with 3form® Capiz resin.

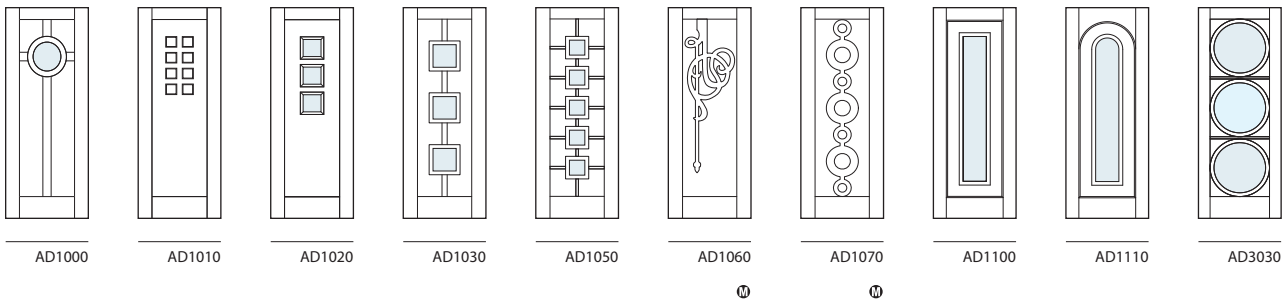
## Tambour Door Styles



## Creative Design Door Styles



-  Arch-top option available
-  Radius-top option available
-  Common-arch pair option available
-  Bi-fold closet option available
-  Available as a fire-rated door\*
-  Available in MDF only

\* Contact TruStile to confirm exact fire ratings and sizes available

## Louver Door Collection (LVR Series)

Our Louver door collection creates architectural interest and enhances a variety of styles. These plantation-style louver doors feature fixed, over-sized louvers in vented and false configurations.



LVR1000 barn doors in Walnut  
with false louver panels

## Louver Door Profile Options

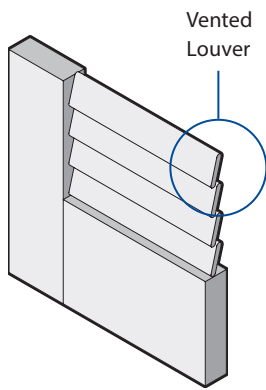

### Vented Louver Doors

Vented louver doors permit air flow making them ideal for closets and laundry rooms where ventilation is preferred.

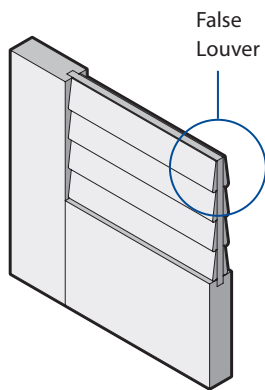

### False Louver Doors

False louver doors are ideal for applications where the appearance of a louver panel is desired, but total privacy is needed.

Both vented and false louver slats are 2"



## Louver Door Styles

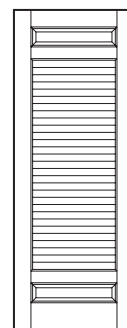
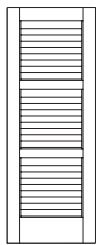
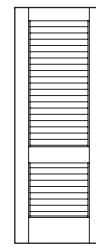
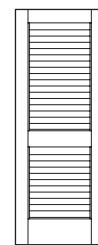
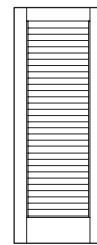

### CREATE YOUR OWN LOUVER DOOR

Louver panels can be added to most door styles with a rectangular panel (minimum size requirements apply). The example on the left features a TS3080 with a middle false louver panel.

# Interior Transoms

Open up interior spaces by allowing in more natural light. Interior glass and panel transoms provide more options for beautiful, dramatic openings.



TRG100 transom in paint-grade MDF above a pair of FL300 barn doors in clear pine with Champagne stain and bevel glass

## Glass Interior Transom Styles

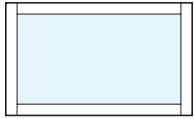

TRG100

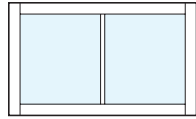

TRG200

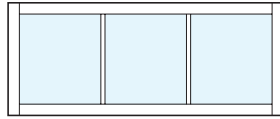

TRG300



TRG400



TRG500

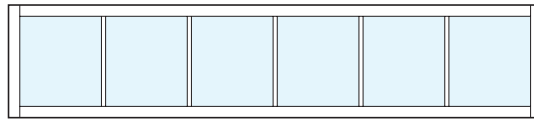

TRG600

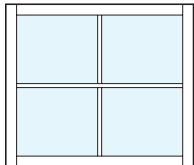

TRG450



TRG606

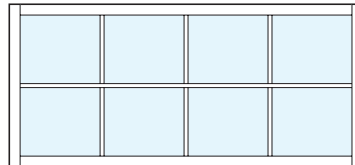

TRG800

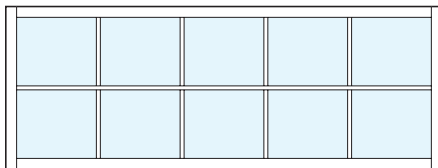

TRG1000

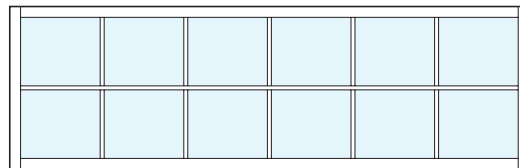

TRG1200

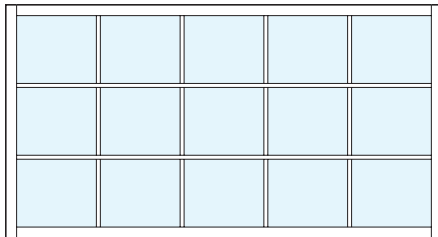

TRG1500

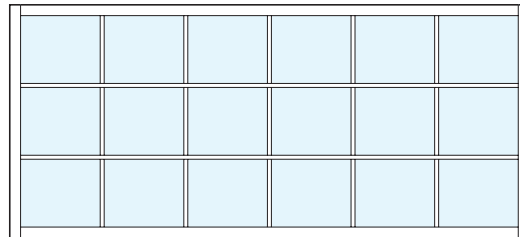

TRG1800

- Both glass and panel designs available
- Wide range of made-to-order sizes available in wood or MDF
- Order with multiple alignment options with or without a 4-sided jamb

## Panel Interior Transom Styles

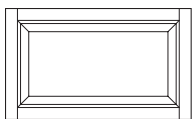

TRP1000

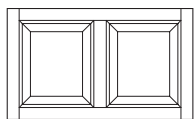

TRP2000

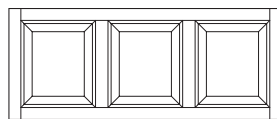

TRP3000

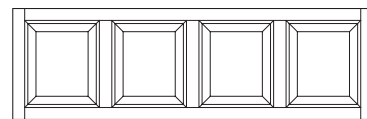

TRP4100

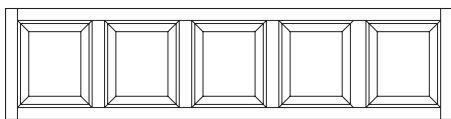

TRP5000

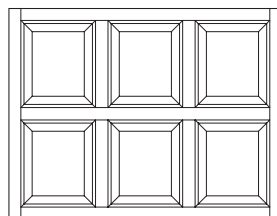

TRP6080

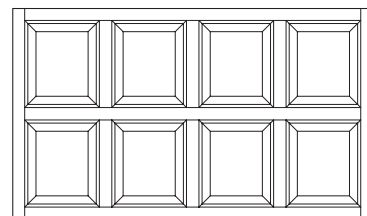

TRP8000



TM9430 in walnut with Nutmeg finish,  
1/8" radius reveals and Flow glass

# Tru&Modern® Door Collection (TM Series)

The Tru&Modern (TM series) door collection consists of over 100 contemporary door styles. A modern take on classic stile and rail door construction. Clean, strong lines. Custom design options. Bold accents. This collection radically alters the concept of what a door can bring to today's modern and contemporary interiors.

## 9-Rail Stacked Rail Door Styles

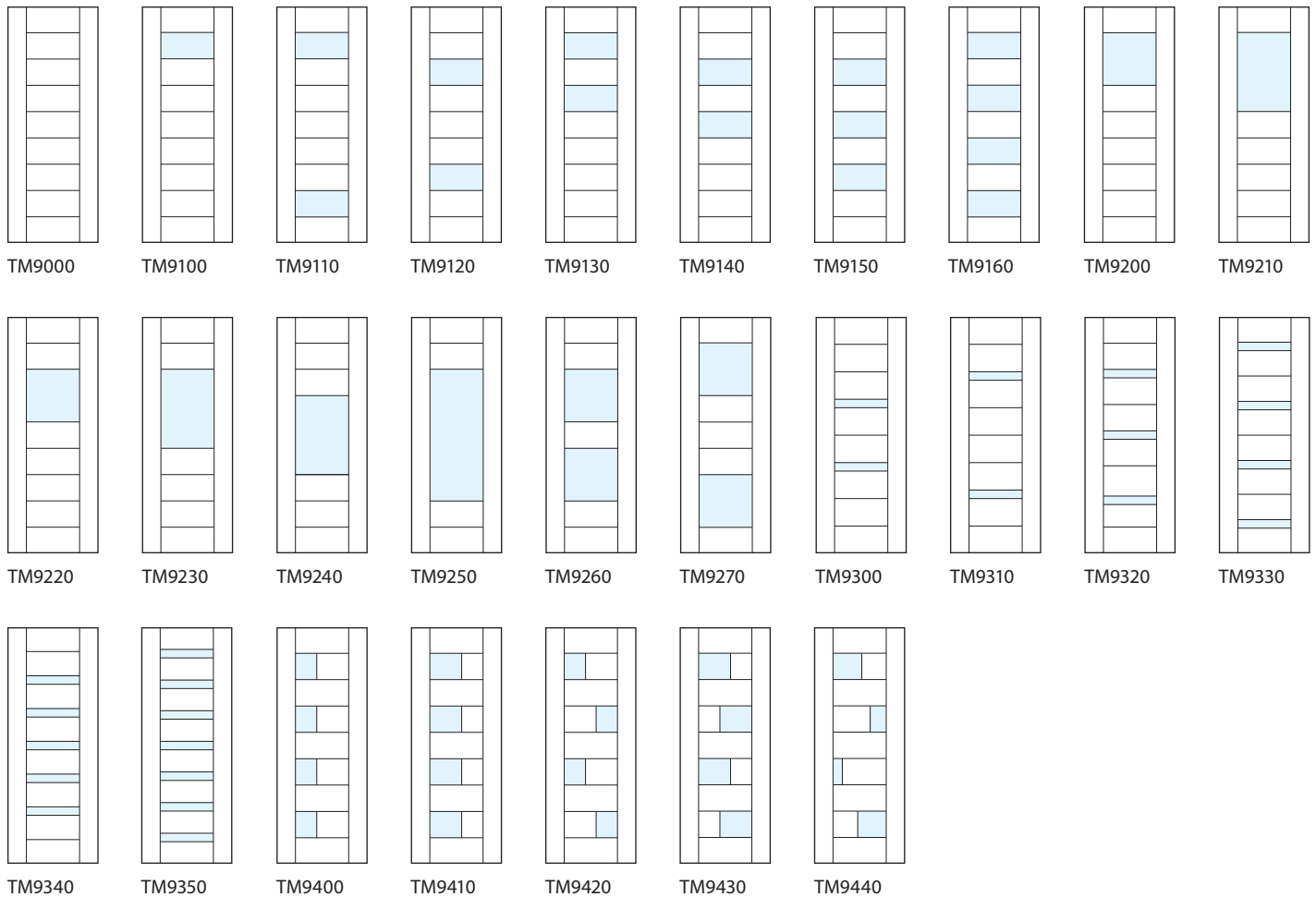

## STILE OPTIONS

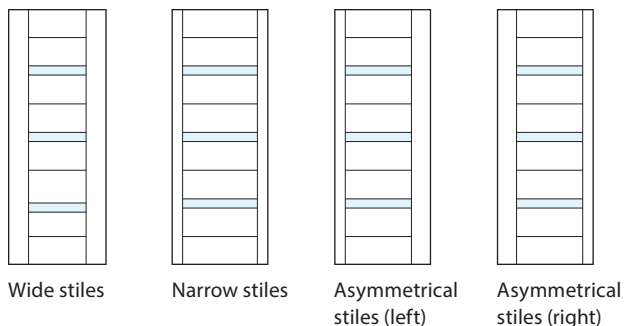

Door styles are shown with wide stile option; narrow and asymmetrical stile configurations are also available. Shaded panels indicate an area for an insert selection to be added: leather, metal, glass, resin or a flat MDF or wood panel options are available.

# Tru&Modern® Door Collection

## 13-Rail Stacked Rail Door Styles

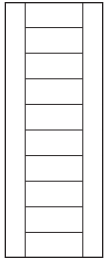

TM10000  
10-Rail

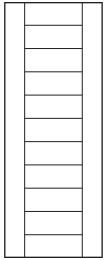

TM11000  
11-Rail

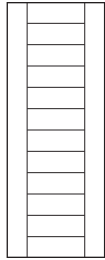

TM12000  
12-Rail

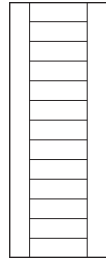

TM13000

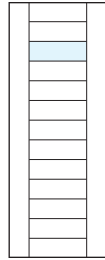

TM13100

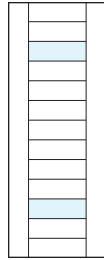

TM13110

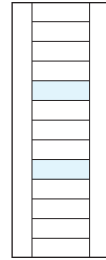

TM13120

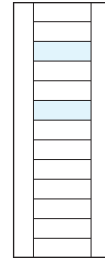

TM13130

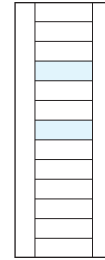

TM13140

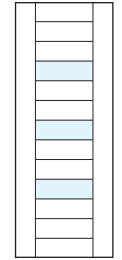

TM13150

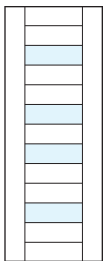

TM13160

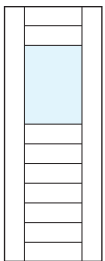

TM13200

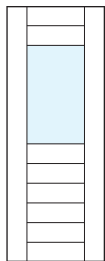

TM13210

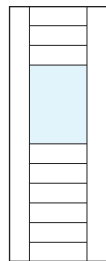

TM13220

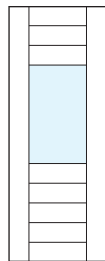

TM13230

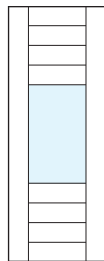

TM13240

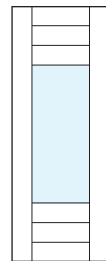

TM13250

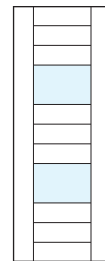

TM13260

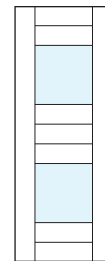

TM13270

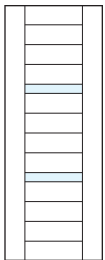

TM13300

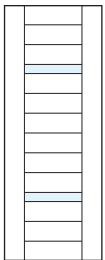

TM13310

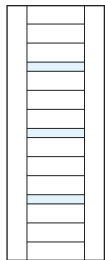

TM13320

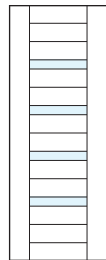

TM13330

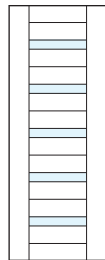

TM13340

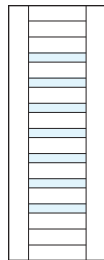

TM13230

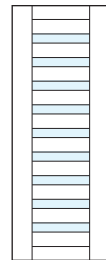

TM13350

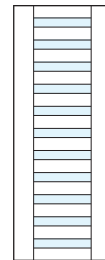

TM13360

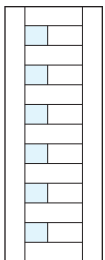

TM13400

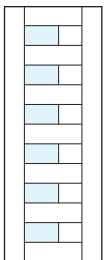

TM13410

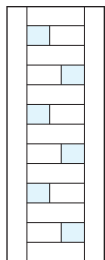

TM13420

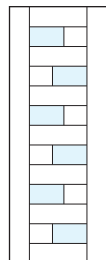



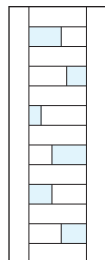

TM13430

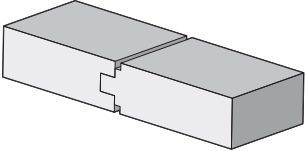
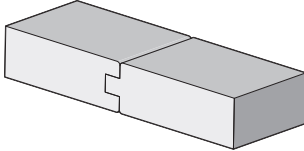
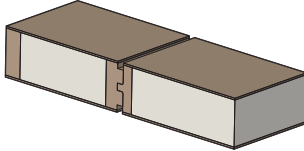
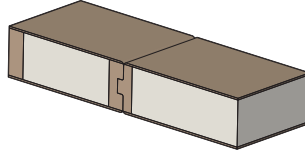
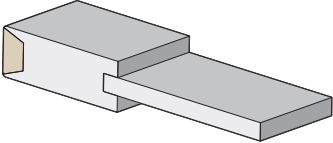
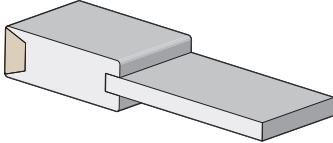
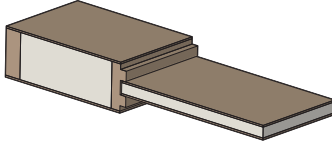
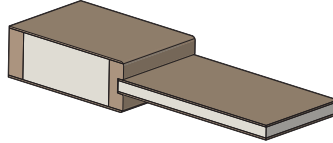
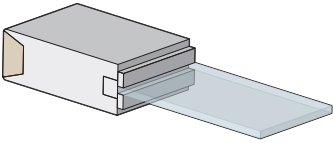

TM13440

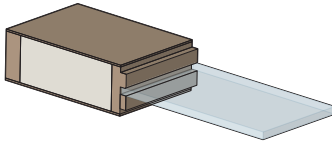
## Stacked Rail Profile Options

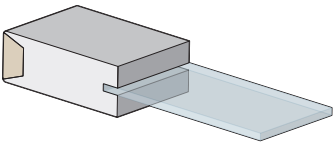
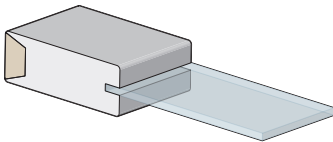
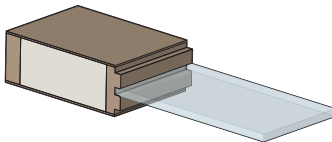
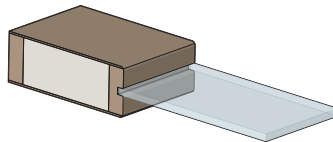
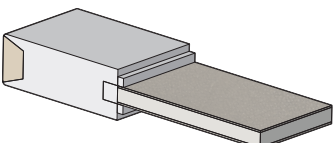
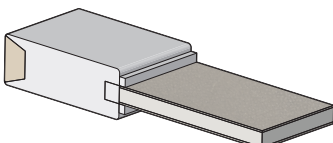
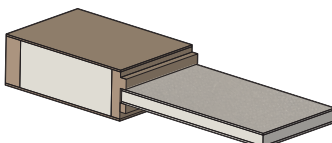
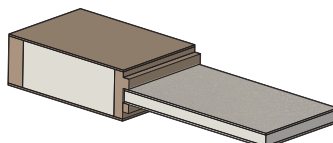
MDF PROFILE OPTIONS		WOOD PROFILE OPTIONS	
<p><b>1/4" KERF CUT REVEAL</b></p>  <p><b>Stacked Rail</b> 1/4" Kerf cut reveal option</p>	<p><b>1/8" RADIUS REVEAL</b></p>  <p><b>Stacked Rail</b> 1/8" Radius reveal option</p>	<p><b>1/4" KERF CUT REVEAL</b></p>  <p><b>Stacked Rail</b> 1/4" Kerf cut reveal option</p>	<p><b>1/8" RADIUS REVEAL</b></p>  <p><b>Stacked Rail</b> 1/8" Radius reveal option</p>
 <p><b>Panel Insert</b> Compression-fit only</p>	 <p><b>Panel Insert</b> Compression-fit only</p>	 <p><b>Panel Insert</b> Compression-fit only</p>	 <p><b>Panel Insert</b> Compression-fit only</p>
 <p><b>Glass Insert</b> Stopped-in</p>	 <p><b>Glass Insert</b> Stopped-in</p>	 <p><b>Glass Insert</b> Stopped-in</p>	 <p><b>Glass Insert</b> Stopped-in</p>
 <p><b>Glass Insert</b> Compression-fit*</p>	 <p><b>Glass Insert</b> Compression-fit*</p>	 <p><b>Glass Insert</b> Compression-fit*</p>	 <p><b>Glass Insert</b> Compression-fit*</p>
 <p><b>Leather/Metal Insert</b> Stopped-in only</p>	 <p><b>Leather/Metal Insert</b> Stopped-in only</p>	 <p><b>Leather/Metal Insert</b> Stopped-in only</p>	 <p><b>Leather/Metal Insert</b> Stopped-in only</p>

\* Compression-fit glass cannot be replaced if damaged



TM3100 in MDF with quirk (QM) moulding and flat (C) panel.

## Tru&Modern® Door Collection

### Modern Adaptations

A new look for popular stile and rail door styles

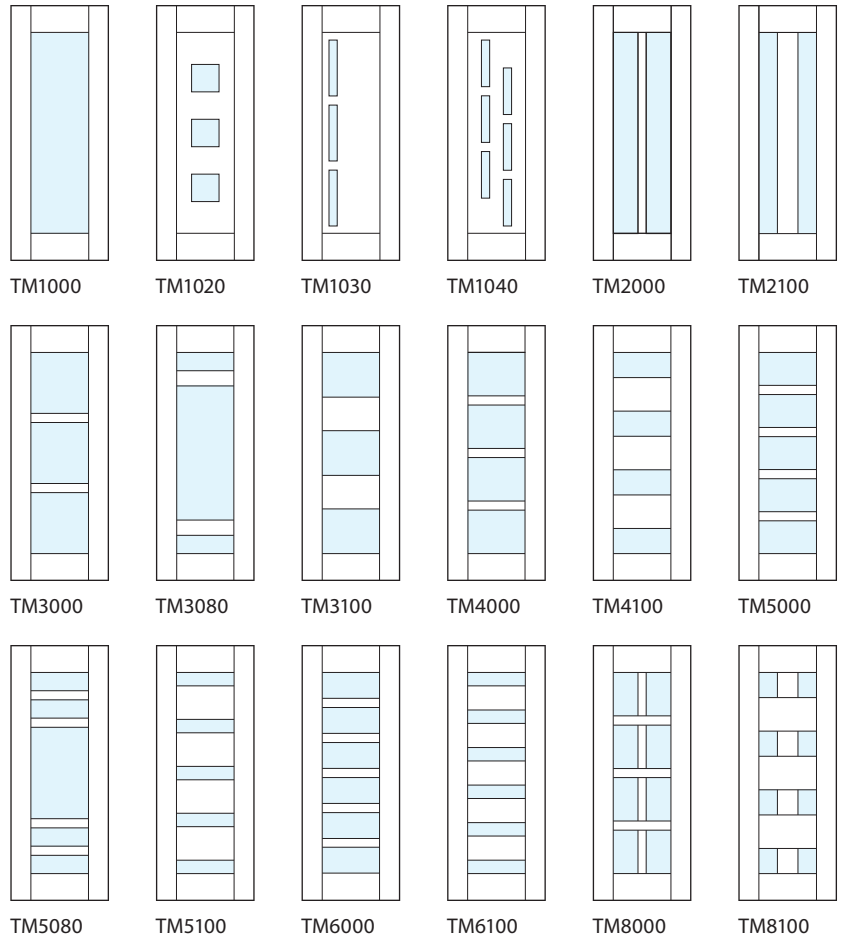

### PROFILE OPTIONS

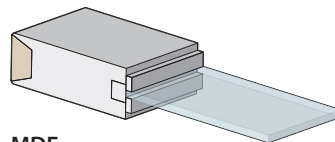

**MDF**  
Stopped-in glass

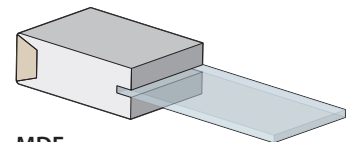

**MDF**  
Compression-fit glass\*

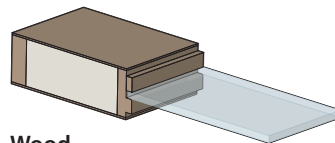

**Wood**  
Stopped-in glass

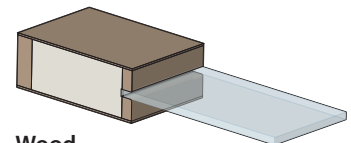

**Wood**  
Compression-fit glass\*

\* Compression-fit glass cannot be replaced if damaged



## Tru&Modern® Door Collection

### Modern Panel Door Styles

Stile and rail doors with glass set within double rails

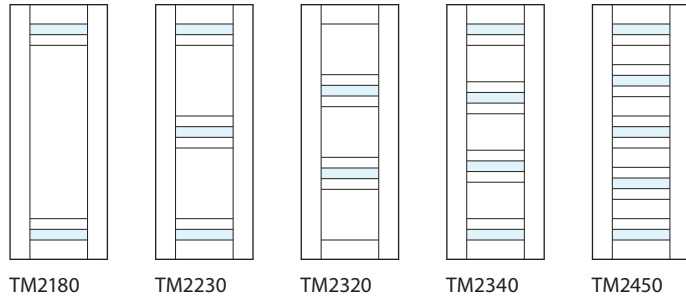

### PROFILE OPTIONS

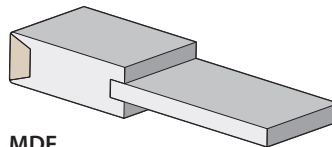

**MDF**  
Flat panel

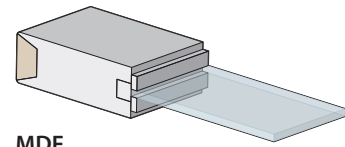

**MDF**  
Stopped-in glass

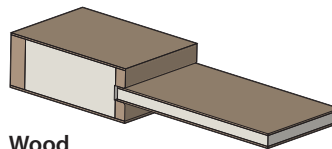

**Wood**  
Flat panel

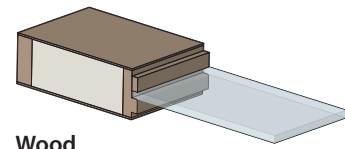

**Wood**  
Stopped-in glass

TM2180 in rift sawn white oak with  
Ebony finish and white lami glass.



## Tru&Modern® Door Collection

### Modern Plank Door Styles

Modern plank panels add a contemporary twist to classic rustic styles.

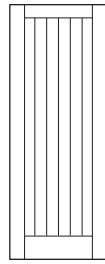

TMP1010

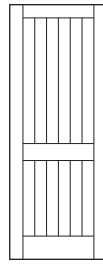

TMP2030

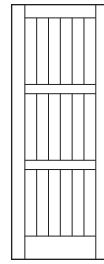

TMP3000

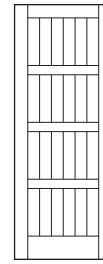

TMP4000

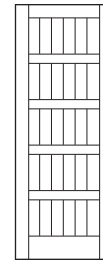

TMP5000

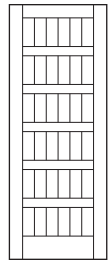

TMP6000

### PANEL OPTIONS

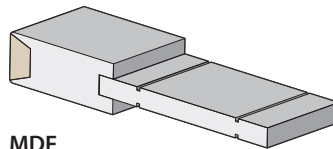

**MDF**  
1/8" Kerf Cut Panel

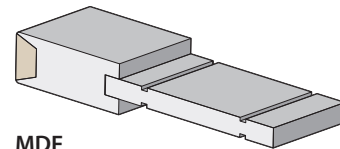

**MDF**  
1/4" Kerf Cut Panel

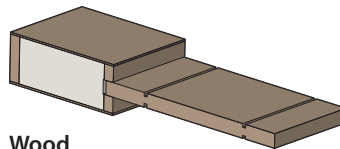

**Wood**  
1/8" Kerf Cut Panel

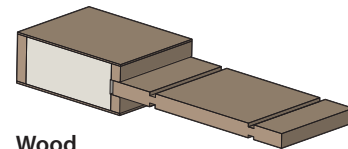

**Wood**  
1/4" Kerf Cut Panel

TMP3000 in MDF with square stick (SS) sticking and 1/4" kerf cut flat panel.  
Shown with drywall return jamb.

*Profiles above shown with square stick (SS) sticking.  
Other standard sticking profiles are also available.*

# Tru&Modern® Ultra-Narrow Doors (TMUN Series)

Impossibly-thin stiles and rails add an airy feel. Substituting panels with glass only adds to the feeling of openness. We recommend using hardware sets with narrow escutcheon plates.

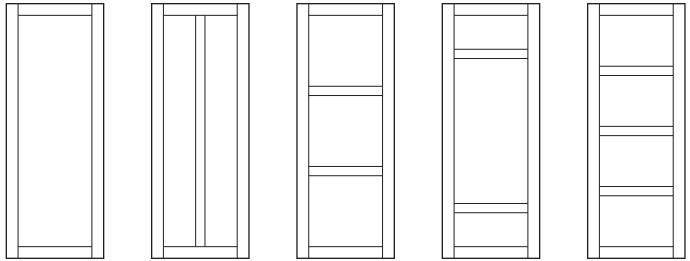

TMUN1000    TMUN2000    TMUN3000    TMUN3080    TMUN4000



TMUN5000    TMUN5080    TMUN6000    TMUN8000    TMUN12000

## PROFILE OPTIONS

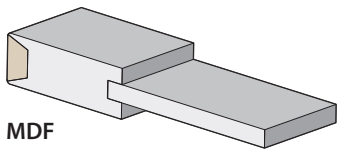

**MDF**  
Flat panel

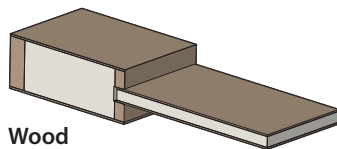

**Wood**  
Flat panel

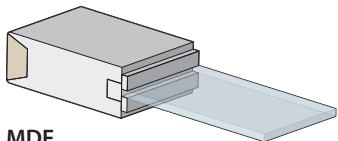

**MDF**  
Stopped-in glass

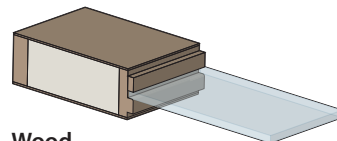

**Wood**  
Stopped-in glass

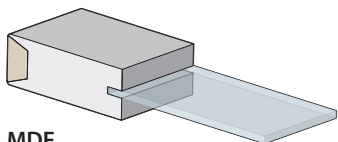

**MDF**  
Compression-fit glass\*

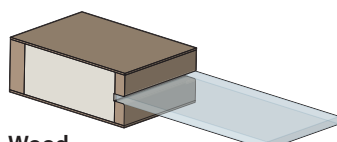

**Wood**  
Compression-fit glass\*

\* Compression-fit glass cannot be replaced if damaged



TMUN5000 doors in MDF with square stick (SS) sticking and clear glass. The door in back has a solid flat (C) panels..



We recommend using narrow hardware sets and escutcheon plates with ultra-narrow doors



TMF1000 flush doors in rift sawn white oak with Hazelnut stain.



# FLUSH DOOR CONSTRUCTION

In 2018, TruStile introduced the first flush door designed for the high-end residential market. Previously, value-engineered, builder-grade doors and commercial office doors were the only flush door options available. TruStile saw a need for flush doors with the refinement required for today's modern interiors.

TruStile flush wood doors feature  $\frac{1}{16}$ " thick hand-selected veneers, precision-matched to optimize the beautiful character found across each species of natural wood. TruStile flush MDF doors feature ultra-refined MDF, the smoothest surface for painted applications, paired with an engineered core for unparalleled stability.

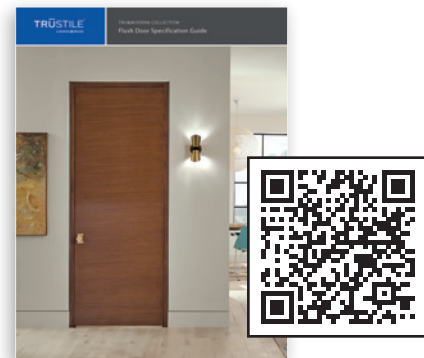

Detailed information on TruStile flush doors is available in our *Flush Door Specification Guide*. Download for free:

[www.trustile.com/flush-guide](http://www.trustile.com/flush-guide)

# Tru&Modern® Flush Doors (TMF Series)

## TruStile Reserve® Flush Wood Doors

- Hand-matched 1/16" veneers are available in both horizontal- and vertical- grain.
- A highly engineered core provides stability for the door while the matching hardwood edge provides a beautiful finish.
- Made to order in sizes up to 4' x 10'.
- Available in most standard wood species.

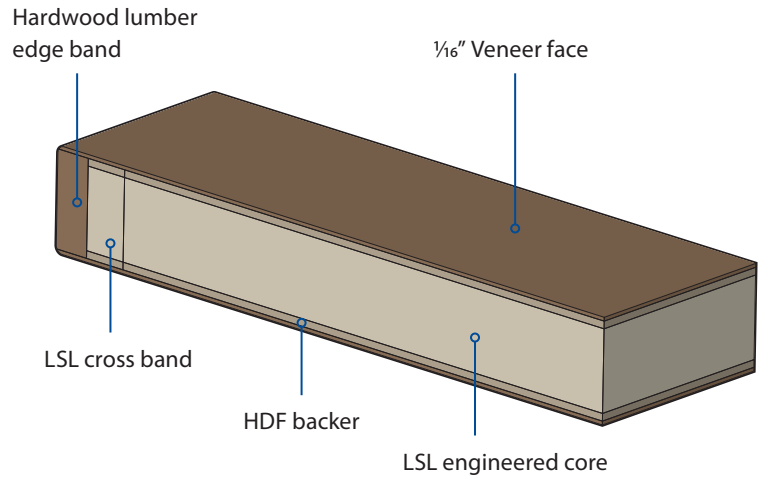

## Hand-Matched Pairs

When hand-matching veneers for a pair of doors, TruStile treats the pattern as though it was covering one extra-wide door. This creates a continuous grain pattern across the width of both doors.

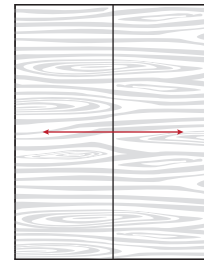

On horizontal pairs, wood grain is continuous across the face of both doors.

## Sketch Face Flush Doors

TruStile offers two sketch face door styles. These create a pattern by combining vertical and horizontal hand-matched veneers on the same door face.

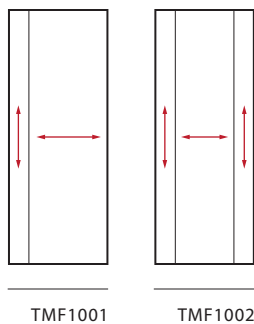



TMF1000 flush door in mahogany with Ebony finish.



TMF1000 barn door in MDF.



## Flush MDF Doors

- Highest quality, super-refined MDF creates a smooth paintable surface.
- A highly engineered core provides stability for the door while the Wedge Edge®, our patented hardwood edge system, provides a secure mount for hardware.
- Made to order in sizes up to 4' x 10'.

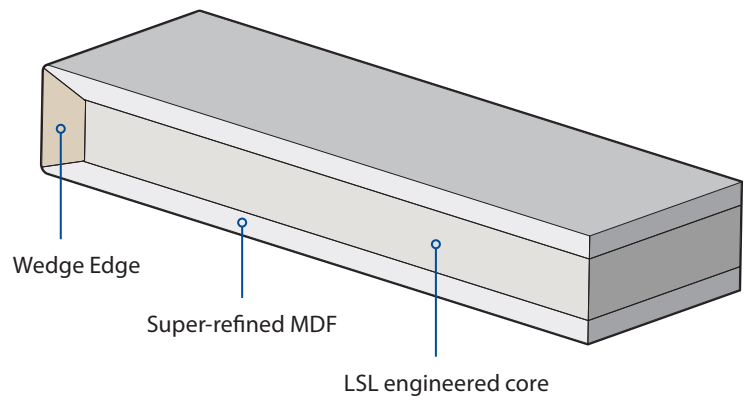



TMP1000 in rift sawn white oak with Honey finish and 1/4" kerf cut reveals.

Flush Doors with Reveals

# Tru&Modern® Plank Door Collection (TMP Series)

## Dynamic Plank Doors

Plank count and size are dynamically adjusted to best fit selected door width

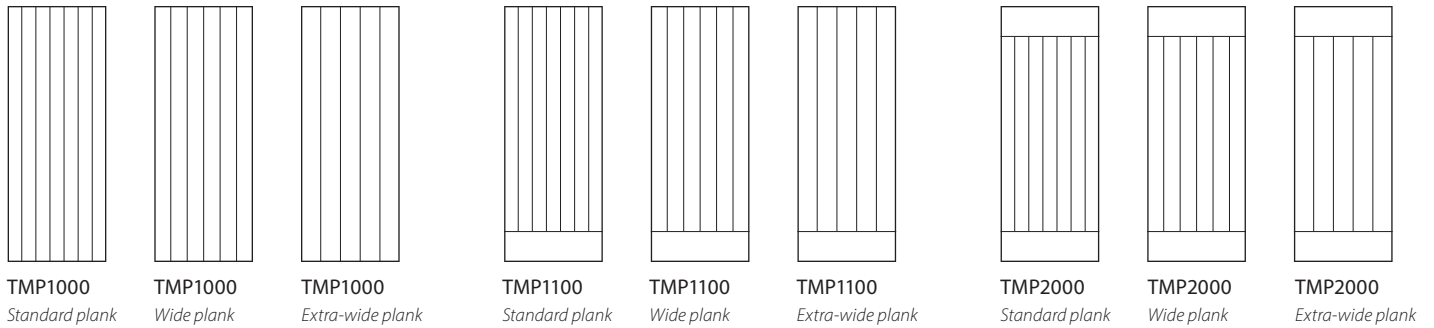

## Fixed Plank Doors

Plank count remains fixed across all door widths

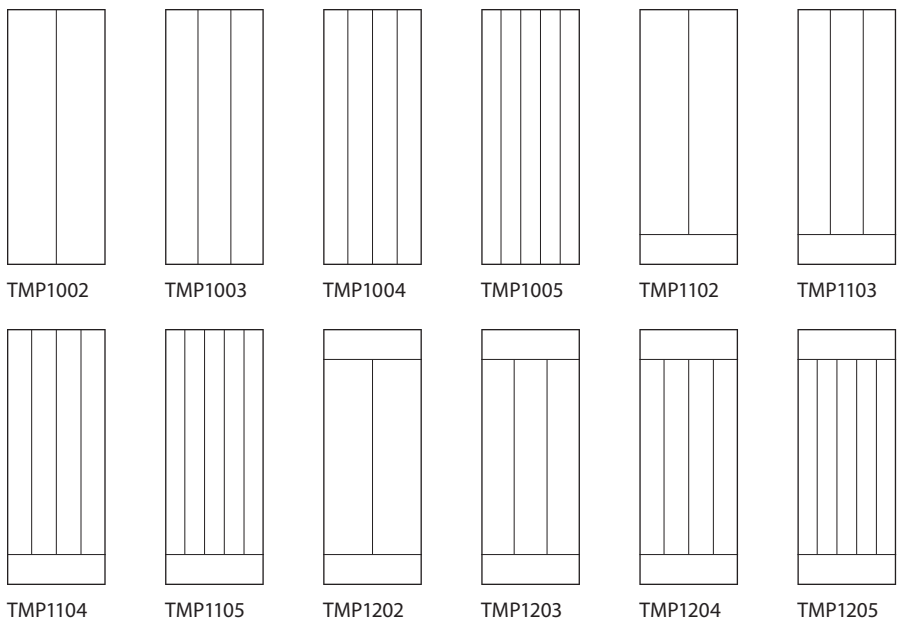

## REVEAL OPTIONS

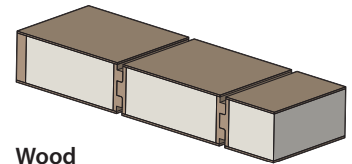

**Wood**  
 TMP1000 wood construction  
 Shown with 1/4" kerf cut

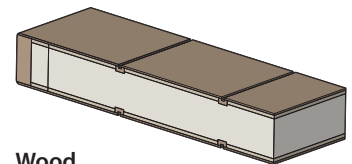

**Wood**  
 1/8" Kerf cut reveal

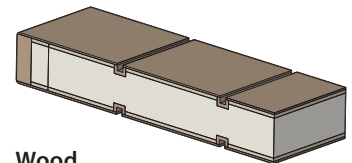

**Wood**  
 1/4" Kerf cut reveal

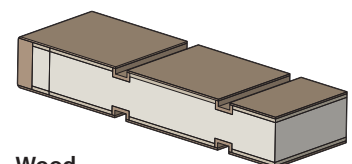

**Wood**  
 1/2" Kerf cut reveal

Door styles are available in both MDF and wood. Wood profiles shown right. MDF profiles are shown on page 87.

On some door styles, veneer seams may not align with kerf and may be visible once door is finished.



TM4101 in MDF with 1/4" kerf cut reveals.

Flush Doors with Reveals

# Tru&Modern® Door Collection (TM Series)

Reveal details add interest and coordinate with other door styles.

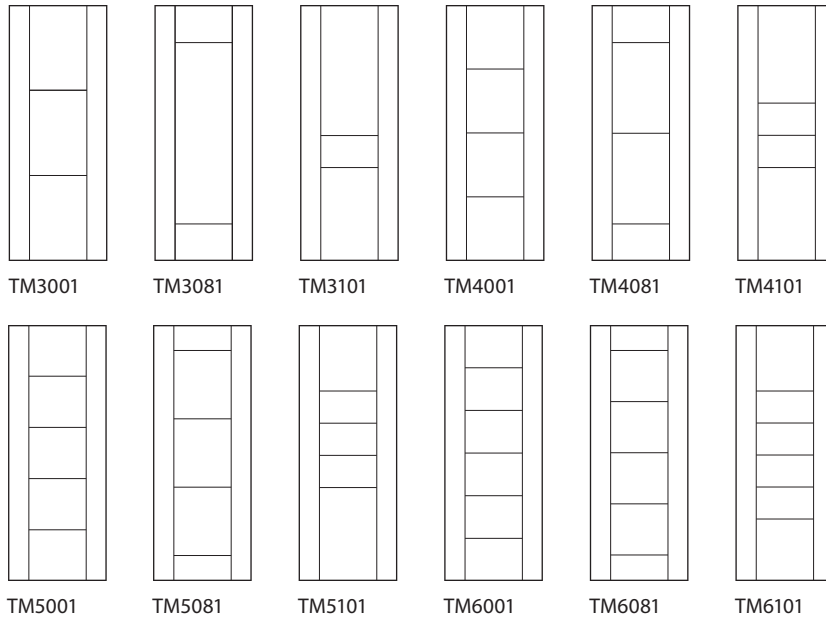

Door styles above are shown with a wide simulated stile configuration. Also available are narrow, ultra-narrow and asymmetrical configurations; which coordinate with modern stile & rail door styles. On wood doors, veneer grain is continuous across the surface; horizontally or vertically depending on your preference.

## REVEAL OPTIONS

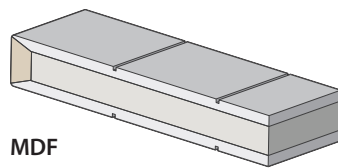

**MDF**  
1/8" Kerf cut reveal

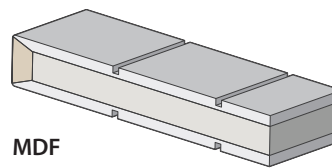

**MDF**  
1/4" Kerf cut reveal

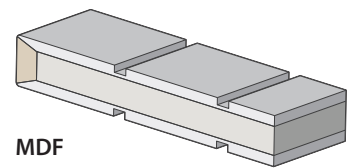

**MDF**  
1/2" Kerf cut reveal

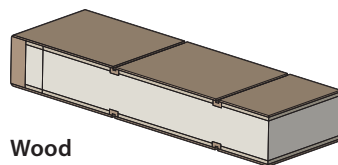

**Wood**  
1/8" Kerf cut reveal

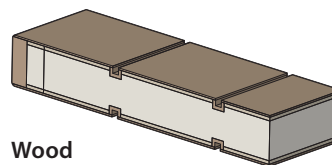

**Wood**  
1/4" Kerf cut reveal

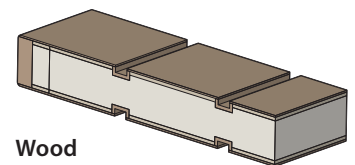

**Wood**  
1/2" Kerf cut reveal



TMIR9001 in plain sawn white oak with Nutmeg finish and 1/4" kerf cut reveal.

Flush Doors with Reveals

# Tru&Modern® Infinite Rail Door Collection (TMIR Series)

Reveal details add interest and coordinate with other door styles

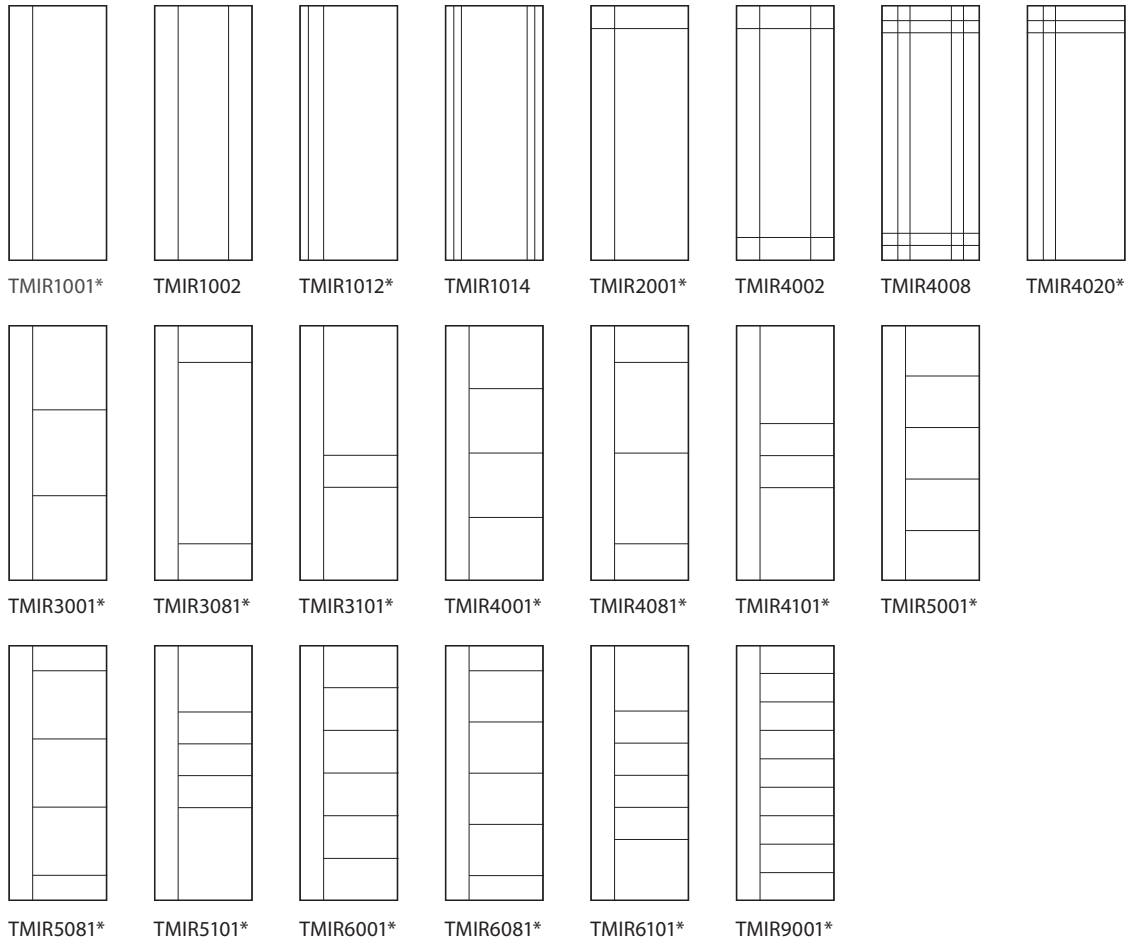

\* Handing can be reversed on door style

## REVEAL OPTIONS

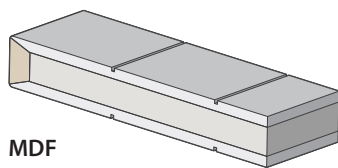

**MDF**  
1/8" Kerf cut reveal

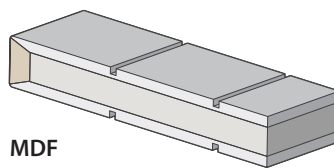

**MDF**  
1/4" Kerf cut reveal

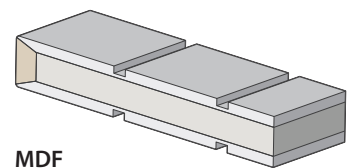

**MDF**  
1/2" Kerf cut reveal

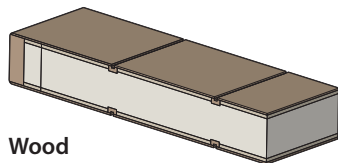

**Wood**  
1/8" Kerf cut reveal

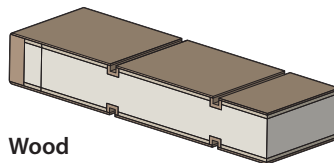

**Wood**  
1/4" Kerf cut reveal

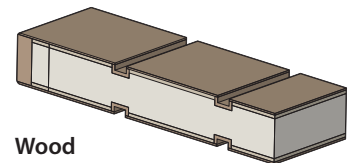

**Wood**  
1/2" Kerf cut reveal





TMF5000 in MDF with 1/4" kerf cut detail.

Flush Doors with Reveals

# Tru&Modern® Flush Door Collection (TMF Series)

Reveal details add interest and coordinate with other door styles.



TMF1200\*  
MDF only



TMF2100\*  
MDF only

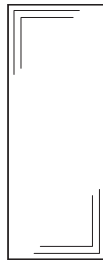

TMF2200\*  
MDF only

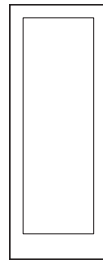

TMF1011  
MDF only

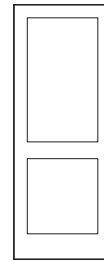

TMF2020  
MDF only

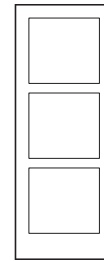

TMF3000  
MDF only

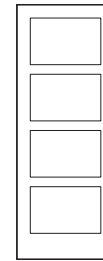

TMF4100  
MDF only

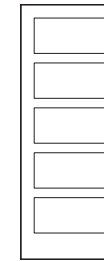

TMF5000  
MDF only

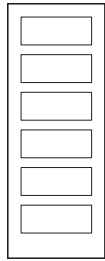

TMF6110  
MDF only

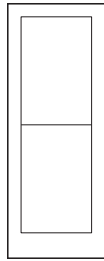

TMF2011  
MDF only

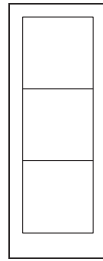

TMF3011  
MDF only

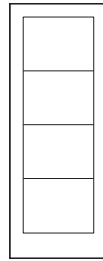

TMF4011  
MDF only

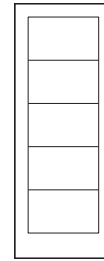

TMF5011  
MDF only



TMF6011  
MDF only



TMF7011  
MDF only



TMF8011  
MDF only

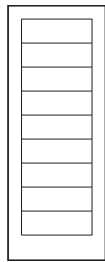

TMF9011  
MDF only

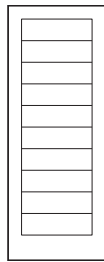

TMF10011  
MDF only

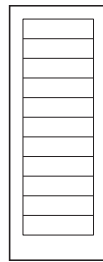

TMF11011  
MDF only



TMF12011  
MDF only



TMF13011  
MDF only

\* Handing can be reversed on door style

## REVEAL OPTIONS

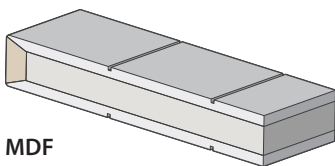

MDF  
1/8" Kerf cut reveal

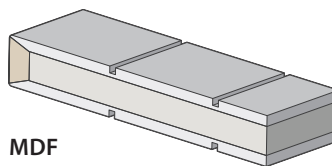

MDF  
1/4" Kerf cut reveal

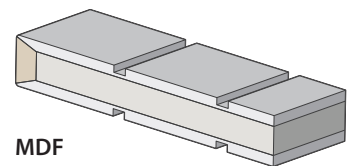

MDF  
1/2" Kerf cut reveal

TMIR3200 in MDF with matte black inlay.  
Show with flush-to-wall jamb with  
1/2" Z-reveal trim.



Flush Doors with Reveals or Metal Inlays

# Tru&Modern® Infinite Rail Door Collection (TMIR Series)

Full-width inlays and reveals create a sleek, sophisticated look

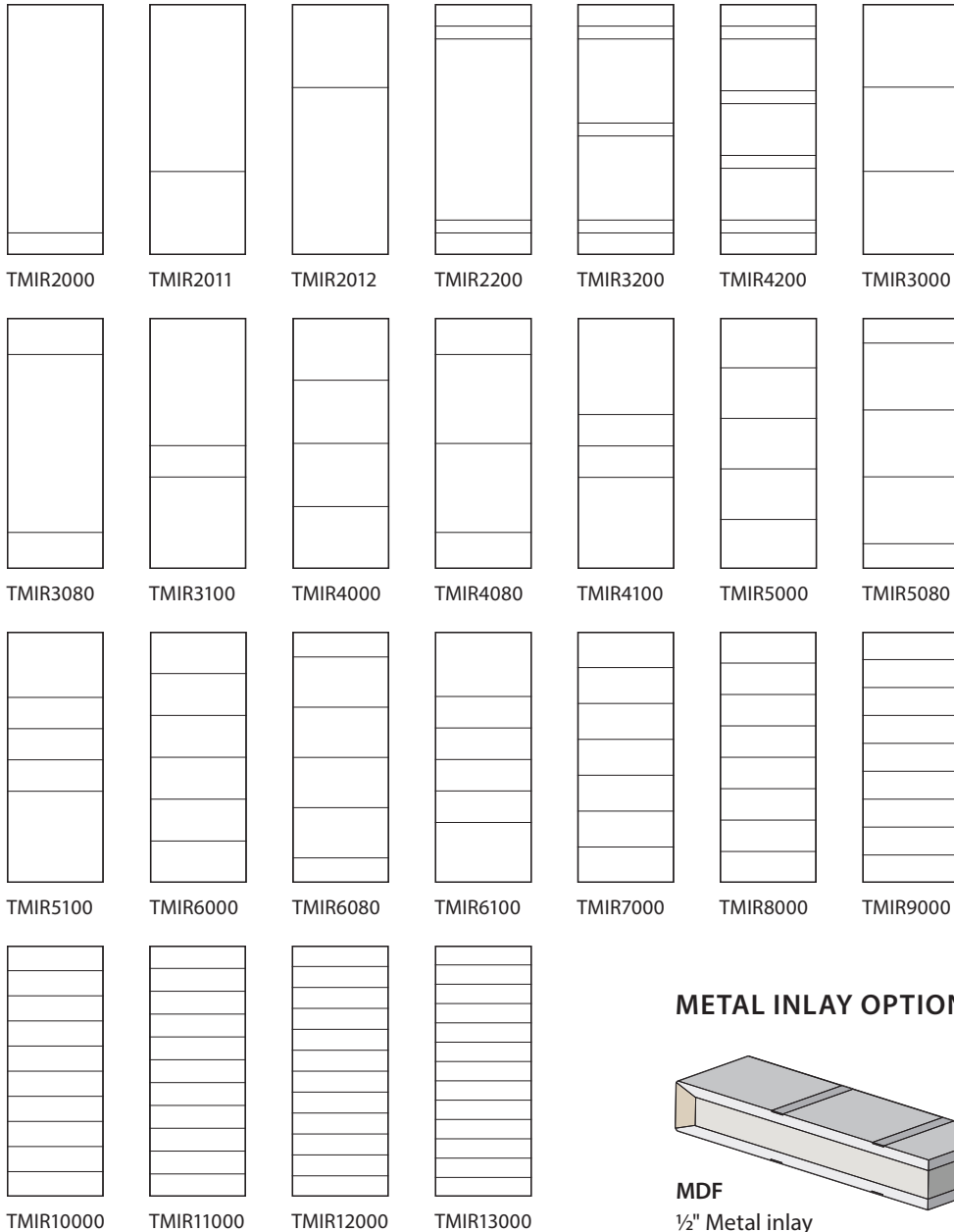

## METAL FINISH OPTIONS



Bright Stainless Steel Finish



Brushed Stainless Steel Finish



Matte Black Finish



Polished Brass Finish



Bright Stainless Steel Finish



Satin Brass Finish

## METAL INLAY OPTIONS

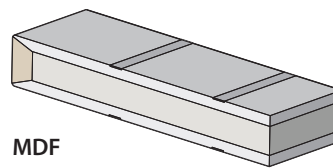

**MDF**  
1/2" Metal inlay

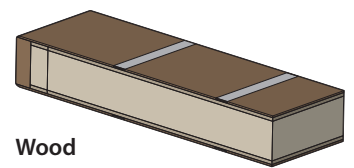

**Wood**  
1/2" Metal inlay

Door styles are available in both MDF and wood; with metal inlays shown above, or any of the kerf cut reveals shown on page 89.



TMFG2012 in mahogany with Slate finish and stopped-in white lami glass.  
Shown with flush-to-wall with jamb reveal.

Flush Doors with Inset Glass

# Tru&Modern® Flush with Glass Door Collection (TMFG Series)

Creative glass panels bring in light and add interest to modern flush doors.

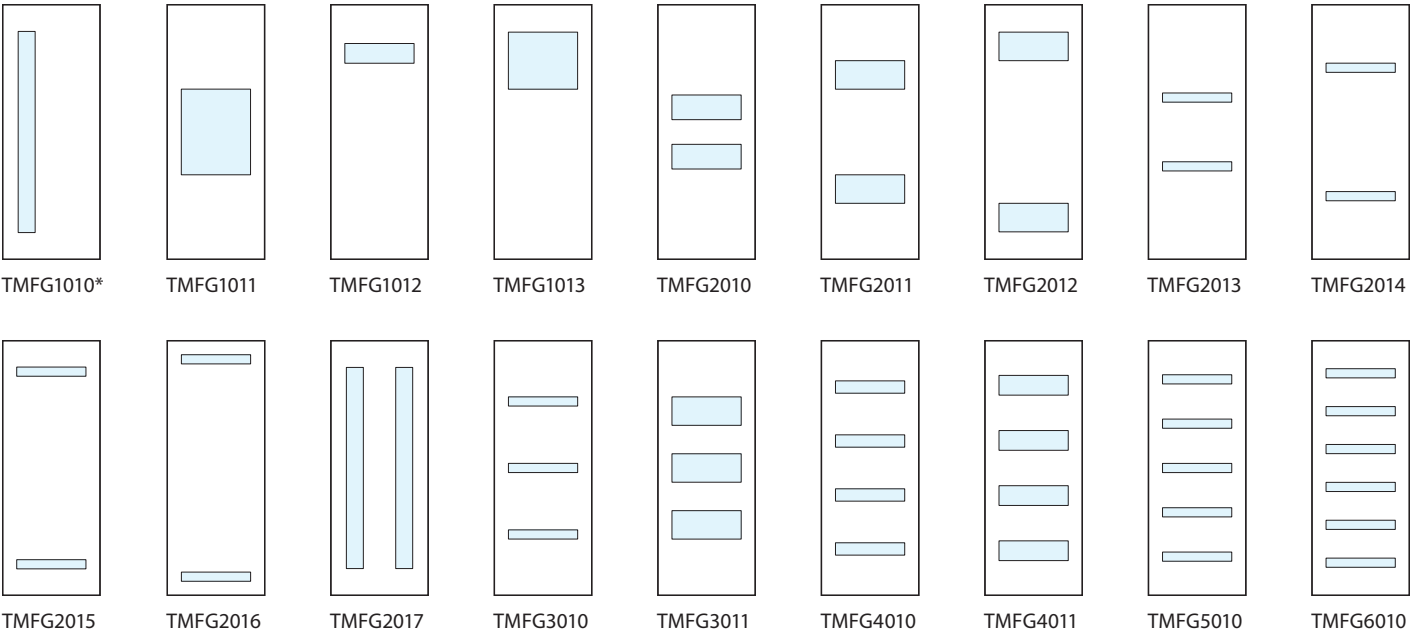

\* Handing can be reversed on door style

### PROFILE DETAIL

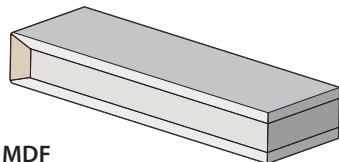

**MDF**  
Flush construction

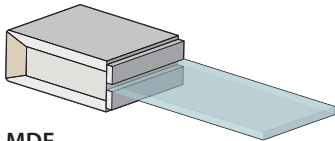

**MDF**  
Stopped-in glass

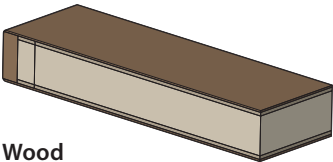

**Wood**  
Flush construction

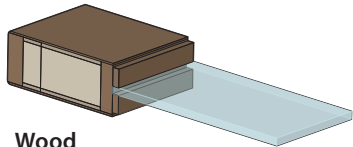

**Wood**  
Stopped-in glass

**Nearly flush appearance**  
At just 1/8" deep x 1/4" wide, the stop used to secure the glass in these door styles is nearly flush with the face of the door.



TM1010 in MDF with ¼" kerf cut reveal and stopped-in white lami glass.  
Shown with projected jamb with inset door and Emtex® square barrel hinges

Flush Doors with Reveals and Inset Glass

# Tru&Modern® Door Collection (TM Series)

Inset glass patterns that integrate with reveal detail.

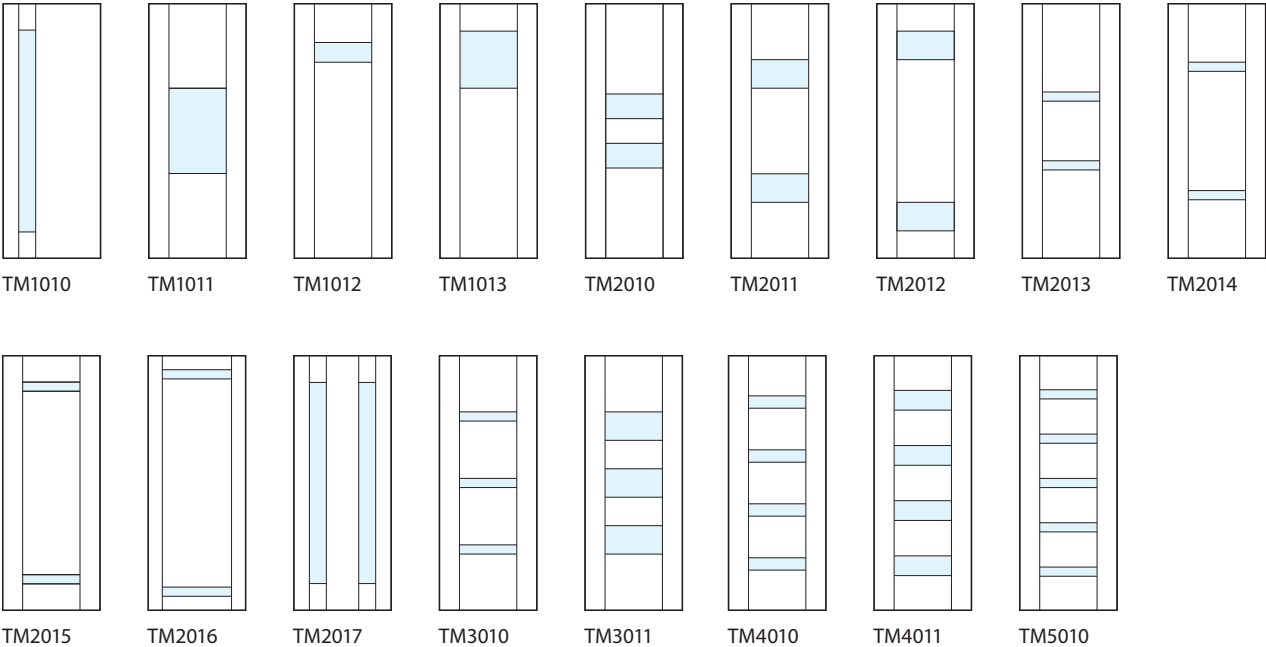

### PROFILE OPTIONS

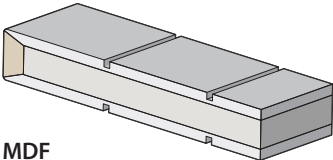

**MDF**  
1/4" Kerf cut reveal

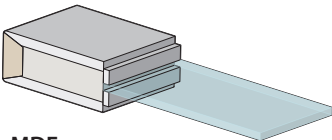

**MDF**  
Stopped-in glass

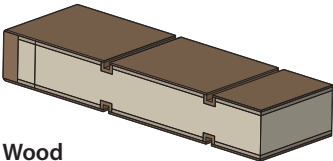

**Wood**  
1/4" Kerf cut reveal

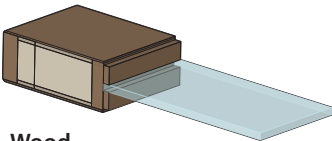

**Wood**  
Stopped-in glass

**Glass stop blends with kerf**

The stop used for glass is sized to align with the 1/4" kerf cut reveals. The veneer grain runs continuously across the face of the door; horizontally or vertically depending on your preference.

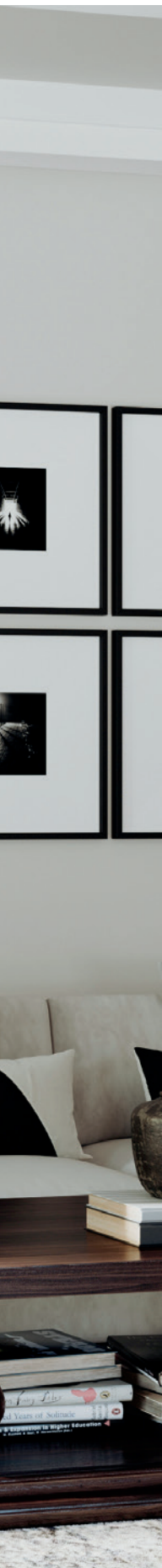

# Design Options

TruStile's made-to-order flexibility makes it easy to customize the look of our standard doors with a collection of unique door options.



TS3160 common arch pair in MDF with bolection (BM) moulding and raised (A) panel.



TS3040 Standard Pair



TS3040 Common Arch Pair

## Common Arch Pairs

Rather than placing two matching doors side by side, common arch pairs carry details, such as curved panels and rails, across both doors. The end result? The doors actually look like they were made for the opening. Common arch pairs are also available with arch- and radius-tops.



**Arch-Top Doors**  
VG2020 AT in Douglas Fir



**Radius-Top Doors**  
Custom radius-top door in MDF



**Sliding Barn Doors**  
TM9320 in MDF with Brushed glass



**Pocket Doors**  
FL1500 in Mahogany



**Bi-Fold Doors**  
TS3160 in MDF



**Bypass Doors**  
VG2020 in MDF



**Pivot Doors**  
TM9140 in LVL with custom metal



**Clipped Corner Doors**  
Custom TS3010 in MDF



**Dutch Doors**  
Custom TS2020 in Mahogany

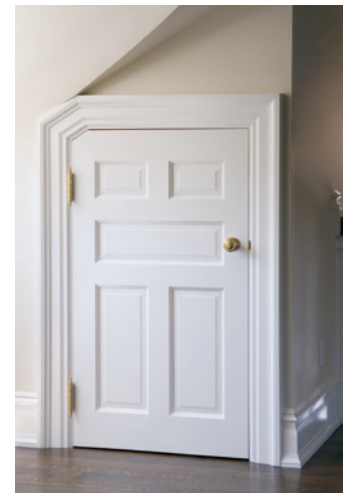

**Specialty Doors**  
Custom TS5060 in MDF



TM13000 in cherry with clear coat finish and 1/4" kerf cut reveals.

# Wood Species

TruStile offers the broadest selection of wood species on the market. Choose from our standard selections or custom order virtually any species.



**Alder, Knotty**



**Alder, Select**



**Birch**



**Cherry**



**Douglas Fir**  
*Vertical Grain*

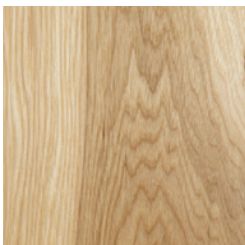

**Hickory**

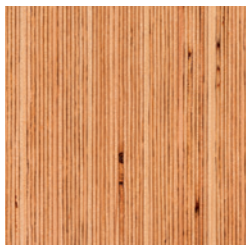

**LVL**  
*Laminated Veneer Lumber*



**Mahogany**



**Pine**  
*Clear Sugar Pine*



**Poplar**  
*Stain-Grade & Paint-Grade*



**Red Oak**  
*Plain Sawn*



**Walnut**



**White Maple**



**White Oak**  
*Plain Sawn*



**White Oak**  
*Quarter Sawn*

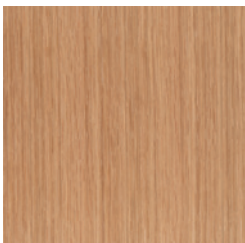

**White Oak**  
*Rift Sawn*

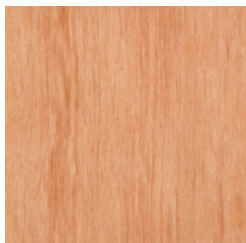

**Wire-Brushed Douglas Fir**  
*Vertical Grain*



**Wire-Brushed Pine**  
*Clear Sugar Pine*

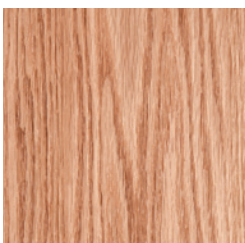

**Wire-Brushed Red Oak**  
*Plain Sawn Only*

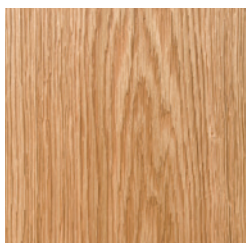

**Wire-Brushed White Oak**  
*Plain Sawn Only*



Our premium, super-refined MDF provides the smoothest surface for painted applications

TS3000 in mahogany with  
Ebony finish, linea (LN) applied  
moulding and flat (C) panel.



# Factory Finish Options

Interior wood doors are all available with a premium hand-wiped finish that accentuates the natural beauty of our doors. Edges of all panels are finished before being inserted into our doors, ensuring unfinished wood is not exposed with environmental changes. Visit [www.trustile.com/finishes](http://www.trustile.com/finishes) to see detailed finish sample images.

	Alder*	Birch	Cherry	Clear Pine	Douglas Fir	Hickory	Mahogany	Poplar	Red Oak*	Walnut	White Maple	White Oak*
Amaretto												
Bleached												
Cameo												
Cappuccino												
Caramel												
Champagne												
Cinnamon												
Ebony												
Espresso												
Grey Mist												
Hazelnut												
Honey												
Nutmeg												
Slate												
White Haze												

\* White oak is available in plain sawn, rift sawn and quarter sawn cuts. Alder available in select alder or knotty alder.

# Innovative Glass and Resin

Replace most any panel with the latest trends in architectural glass from Bendheim® or designer resin from 3Form®

## Glass & Mirror Options



Clear



Bevel

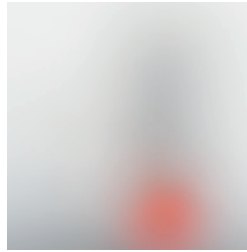

Frosted

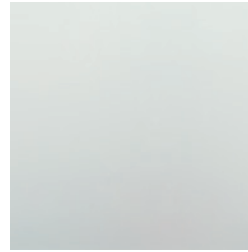

White Lami



Arctic

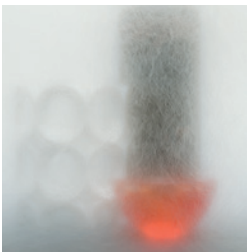

Brushed



Clear Leaf

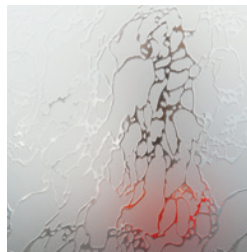

Delta Frost

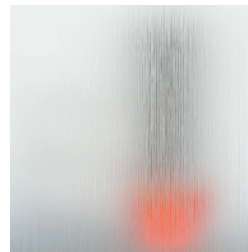

Flow

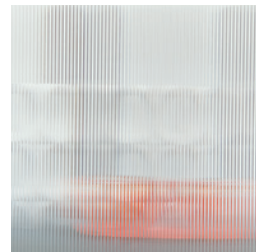

Groove



Master Carre



Obscure

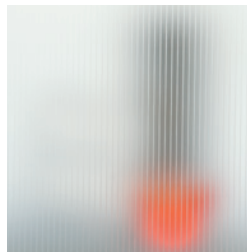

Pinstripe



Rain



Reeded



Satin Barcode



Seedy Wash



Shoji



Spun



Tuxedo



Wave



Whirl



Bronze Fibers Mirror

Please see your dealer for the most recent available glass options.

## 3form® Resin Options

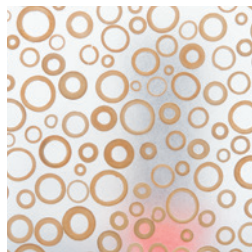

Bamboo Rings

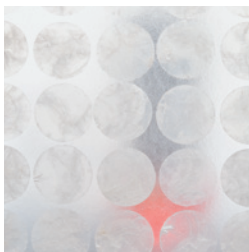

Capiz

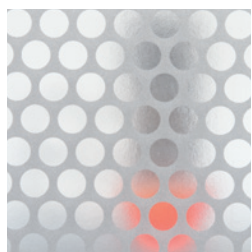

Cirque



Fossil

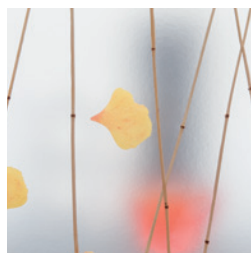

Ginkgo Thatch

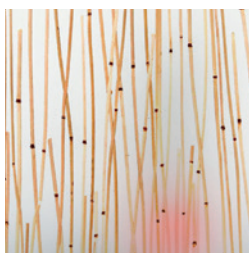

Thatch

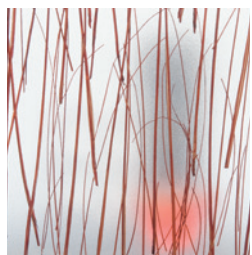

Ting Ting



TM9430 in walnut with Nutmeg finish, 1/8" radius reveal and Flow glass inserts.

Visit [www.bendheim.com](http://www.bendheim.com) and [www.3-form.com](http://www.3-form.com) for hundreds of custom glass and resin options.

# Built-In Mirrors

TruStile mirror doors add a new dimension to any space. Our mirror doors are a perfect space-saving solution for bathrooms, closets, dressing rooms and other applications where a full-length mirror is required on one side.



Clear mirror

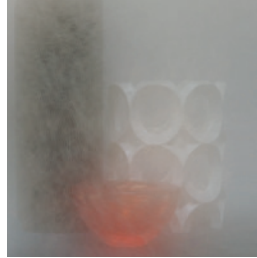

Bronze Fibers Mirror

Achieve total design form and function by substituting any solid panel for a mirror. Standard options include clear mirror and bronze fibers mirror.

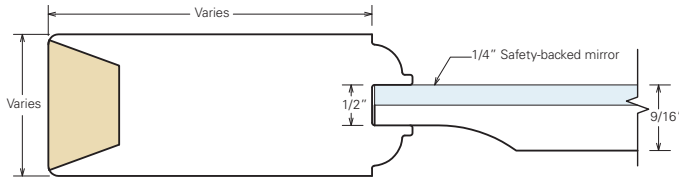

Sample cross section (one-sided mirror door)

## Custom Etched Glass

Looking for something special for a pantry, wine cellar or office door? TruStile can custom etch any pattern, word or logo onto your glass doors.



Specify a full-length, built-in mirror on the back of any of our panel doors.



Backside of TM9000 in MDF features built-in mirror. TM5000 with white lami glass on left.

# Metal Panels

High-quality wood and imaginative finishes combine for an entirely new perspective on what a modern interior can be. Substitute almost any panel for a decorative metal insert from architectural supplier Chemetal®.



Brushed Aluminum

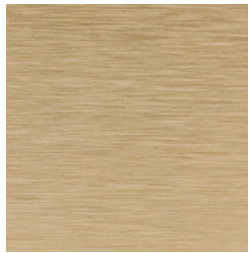

Brushed Brass



Brushed Bronze

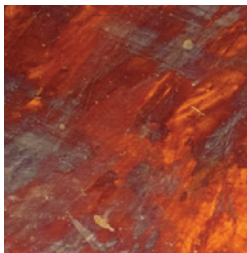

Patina Aurora



Patina Canterbury



Patina Monet

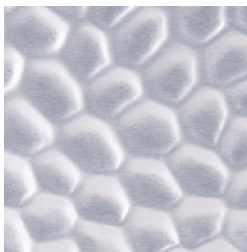

Hammered Argenta

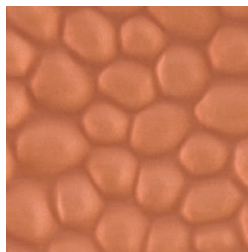

Cobble Stone  
*Limited availability*

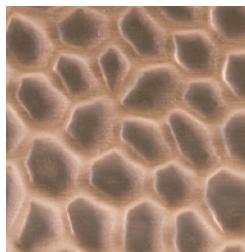

Reptilian  
*Limited availability*



# Metal Inlays

Metal Inlays are available on our Infinite Rail (TMIR series) interior door styles with horizontal kerfs, shown on page 93.



Bright Stainless Steel



Polished Brass



Satin Black

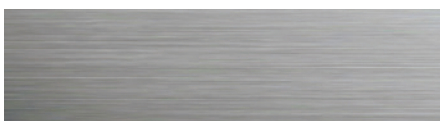

Brushed Stainless Steel



Brushed Light Brass



Satin Copper

# Edelman® Leather

Substitute almost any panel with the finest Edelman leather. Select either a laminated or upholstered appearance for your leather panels.

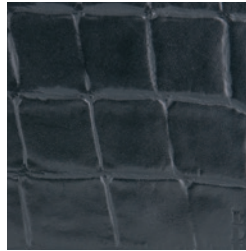

Croc Black

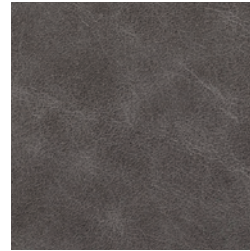

Dashing Old Sterling



Shagreen Café Latte

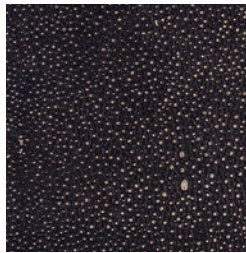

Shagreen Caviar



Shagreen Couscous

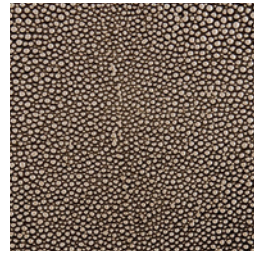

Shagreen Grey Oyster



Sulky Grey Mare

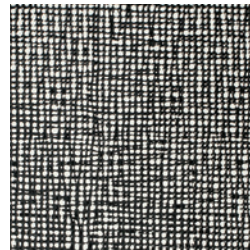

Wagon Lit Milk & Cookies



Wagon Lit Newest Navy

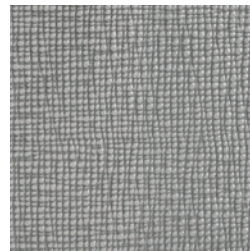

Wagon Lit Sonic

**Opposite page:** TS3000 with Roman ogee (OG) sticking and Patina Monet panel

**Above:** TM9340 in walnut with Nutmeg finish, 1/4" kerf cut reveals and Shagreen Café Latte leather

# Hinges



Shown in Satin Nickel

## Simonswerk®

### Tectus Concealed Hinges

Simonswerk Tectus concealed hinges offer a sleek, clean look perfect for today's modern interiors. These precision hinges are fully adjustable in three dimensions, making it simple to create a perfect margin between the door and frame.

Our concealed hinge offering is available on any of our 1- $\frac{3}{4}$ " or 2- $\frac{1}{4}$ " thick doors and provides a complete solution: precision-machined door, fully prepped ready-to-assemble jamb and choice of Tectus hinges. Not available on pre-hung units.

## Emtek®

### Square Barrel Hinges

Emtek square barrel hinges offer a unique, modern rectangular spine profile when the door is closed. With smooth action, a solid brass construction and loads of style, these hinges offer a sophisticated look and feel.

The hinge barrel also features no exposed screws for an aesthetically clean look, unlike some other options on the market.

Emtek square barrel hinges are available in 3- $\frac{1}{2}$ "  $\times$  3- $\frac{1}{2}$ ", 4"  $\times$  4" and 4- $\frac{1}{2}$ "  $\times$  4- $\frac{1}{2}$ " sizes and are available in a wide variety of finishes.



Shown in US4  
Satin Brass finish



Shown in US10B Oil-Rubbed Bronze finish

## TruStile® Hinges

### Heavy Duty Ball-Bearing Hinges

TruStile offers architectural-grade, square corner, ball bearing hinges custom built to its specifications.

Doors that are ordered pre-hung receive 4" hinges on 1-3/4" doors, while 1-3/8" doors receive 3-1/2" hinges.

4-1/2" hinges are available for 1-3/4" and 2-1/4" doors. Hinges can also be ordered for TruStile doors not pre-hung at the factory.

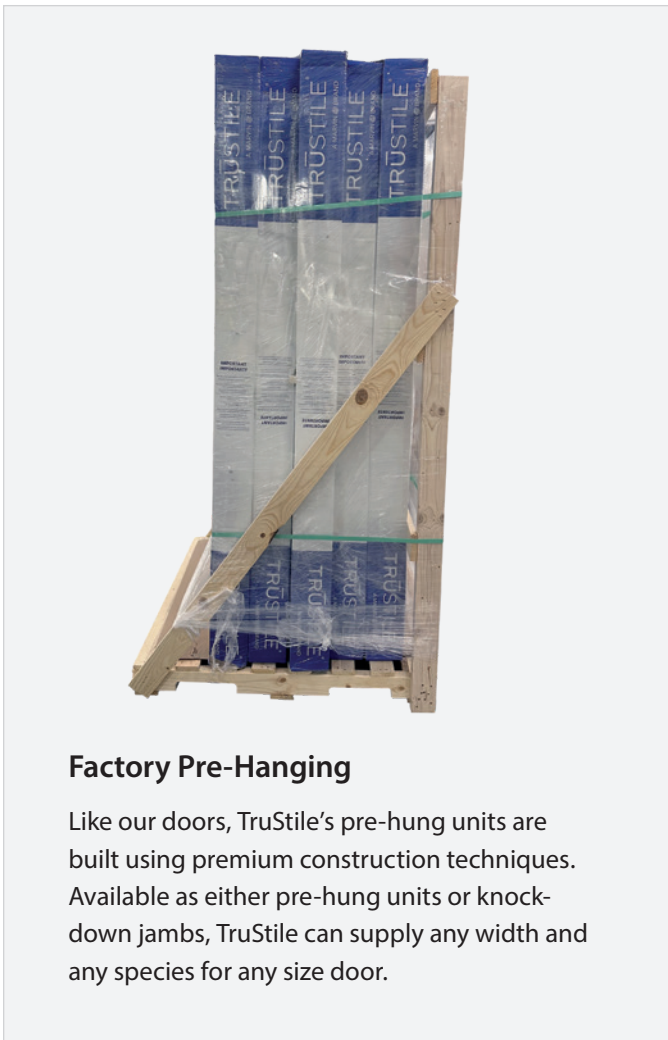

### Factory Pre-Hanging

Like our doors, TruStile's pre-hung units are built using premium construction techniques. Available as either pre-hung units or knock-down jambs, TruStile can supply any width and any species for any size door.

### Available Hinge Finishes



US3 Bright Brass



US4 Satin Brass



US5 Antique Brass



US10A Antique Bronze



US10B Oil-Rubbed Bronze



US14 Polished Nickel



US15 Satin Nickel



US15A Antique Nickel



US19 Flat Black



US26 Polished Chrome



US26D Satin Chrome

# Jambs

## Traditional Jambs

TruStile has streamlined the ordering process and made it easy to design jamb solutions for every opening. Choose from stain-grade and paint-grade materials to match the doors and trim of your space.

Our traditional jambs are available pre-hung, or as a knockdown assembly, and are available with fire ratings. Choose from a variety of configurations including single or double rabbet jambs or flat jambs with applied stop.

## Modern Architectural Door Jambs

In addition to our traditional jamb offering, TruStile has introduced a new line of modern casing-less door jambs. These jamb configurations bring high-end, configurable designs that complete the look of modern openings in your projects.

Discerning building professionals and their clients will appreciate the innovative options that create seamless lines and eliminate the need for casing around each door throughout the home.

### Flat Jambs with Applied Stop



### Projected Jamb with Inset Door

Exposed jamb edge projects from wall with inset door that is flush to wall



### Flush-to-Wall Jamb

Exposed jamb edge with door and jamb flush to wall, shown with drywall reglet reveal.



### Single Rabbet Jambs



### Double Rabbet Jambs



### Projected Jamb and Door

Exposed jamb edge projects from wall with door that sits flush to edge of jamb



### Drywall Return Jamb

Semi-concealed jamb edge with door and jamb recessed in wall



### Flush-to-Wall Jamb with Reveal

Exposed jamb edge with door and jamb flush to wall, reveal built into jamb



Our complete TruStile jamb offering is detailed in our *Interior Residential Jambs & Accessories Specification Guide*.

Download for free at:  
[www.trustile.com/jamb-guide](http://www.trustile.com/jamb-guide)



TMIR6000-106B in mahogany with Nutmeg finish and 1/4" kerf cut reveals.



*TruStile entry systems are available solely for residential applications.*

## Wood Entry Systems

Make the entry to your home a most welcoming invitation with an exceptional entrance by TruStile. In collaboration with our parent company, Marvin®, we have engineered a family of premium entry systems that don't just transform a space, but how you feel inside it.

With the Reserve Wood Entry Systems™ and Resilient Wood Entry Systems™ you have two options that take exterior doors to the next level. The Resilient Wood Entry System sets the tone of quality for the whole home using the most durable paint-grade construction without sacrificing any design options. The Reserve Wood Entry System elevates the refined elegance of your home with the beauty of stained natural wood.

Both entry system solutions have been extensively tested and proven in partnership with the Marvin® Research and Development team.

**MARVIN®** 

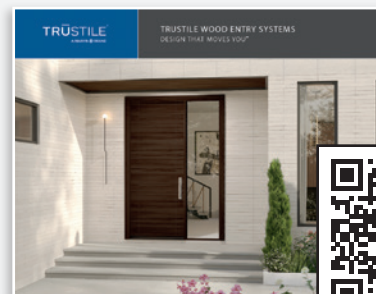

For more information about our wood entry systems, download a copy of our Entry Systems Catalog.

[www.trustile.com/entry](http://www.trustile.com/entry)



TMIR1002-102B in walnut with Ebony finish and 1/4" kerf cut reveals.



LVL core is stable even in outdoor environments

Premium flitch veneers provide consistent grain

Tricoya outer layers provide exceptional stability and durability

Industry-leading color matching standards

## Reserve Wood Entry System™

The Reserve Wood Entry System elevates the refined elegance of your home with the beauty of stained natural wood.

- Engineered with a laminated veneer lumber (LVL) core and Tricoya® layers to provide exceptional stability and durability.
- 10 natural wood species available with an extensive collection of premium factory stain options.
- Premium appearance standards ensure industry-leading grain and color matching.
- 5-year limited warranty with industry standard overhang requirements for both in-swing and out-swing units.





An overview of Reserve and Resilient Entry Systems is available for download as an information sheet.

[www.trustile.com/info/entry](http://www.trustile.com/info/entry)

PL224-107 in Resilient engineered wood with cove & bead (CB) sticking, raised (A) panel and clear glass.

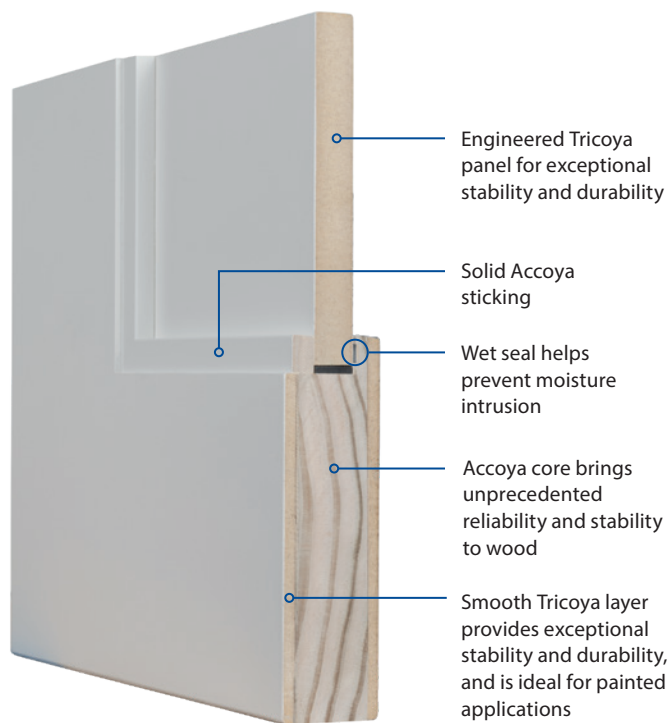

### Resilient Wood Entry System™

The Resilient Wood Entry System sets the tone of quality for the whole home using the most durable painted construction without sacrificing any design options.

- Engineered with resilient Accoya®, an acetylated wood product, which brings unprecedented reliability and durability to wood.
- Tricoya® top layers provide exceptional stability, durability and paintability, for outdoor applications.
- Most configurations delivered pre-hung with an Accoya built jamb and a premium prime finish, ready to paint to match your design.
- 10-year warranty with limited and no-overhang applications, depending on system design specifications, for both in-swing and out-swing units.





TS6050 in maple with Roman ogee (OG) sticking and scoop (B) bladder-pressed panel.



## Commercial Specifications

From hospitality and high-end multifamily projects to health care and educational institutions, TruStile provides the right finishing touches for distinctive projects across the United States.

TruStile doors can be built to meet any commercial specification — including 20- through 90-minute fire ratings, ADA requirements and sound ratings.

## Design Consistency Regardless of Function

Providing ultimate design flexibility, TruStile offers a spectrum of products for every project application. Whether passage, glass, fire or sound doors, TruStile allows you to maintain design consistency across all of your openings.



TS2020 in MDF with custom sticking.



TM9000 in white oak with 1/4" kerf cut reveal.



Massive TS4100 doors in cherry with clear glass.



Historic match custom multi-panel doors in MDF with bolection (BM) moulding and senior raised (E) panel.

## Transform Openings & Elevate Your Project

TruStile designs premium doors for a wide array of market segments and distinctive properties across the United States.

### Recent Projects

---

#### Multi-family

Art House  
Albany  
Alys Beach  
Aqualina  
Eleven on the River  
Infinity  
LeParc  
Meridian  
Regency Parc  
Rosewood  
Serrana  
Selene  
Hyde Park  
Bayso  
Nashville Yards  
Saltaire  
Treehouse  
Edwards Ranch  
Ritz Residences  
Santa Monica Lowes  
Goldwynn  
The Manning  
Book Tower  
Fairmont Museum Apartments  
Pinnacle at Waypointe

#### Hospitality

Residence Inn Reno  
Embassy Suites Gulf Shores  
Marriott Newport  
Omni Severin  
Towneplace Suites  
Fairmont Hotel  
Magnolia Hotel  
The Veranda House Inn  
Nittany Lion Inn  
Daphne Hotel  
Hilton Nashville  
Hilton Garden Inn  
Inns of Aurora Farmhouse  
Camelback Inn Spa  
Marriott Camelback  
Marriott Houston

Westin Atlanta/Hilton Head  
Ritz Carlton St. Thomas  
Sheraton Commander  
Intercontinental  
Sheraton Steamboat Springs  
Hotel Floridian  
Aldelphi Hotel  
The Gaylord

#### Education

Dartmouth College  
St. Phillips Academy  
UVM Rouss Robertson  
UM Alpha Delta Pi  
University of PA Dorm  
Cambridge Housing  
Lesley University- Cambridge  
Hillsdale College  
Kappa Sigma House - UofA  
Yale Student Living  
Smith College  
Brown University  
t Elston Hall  
Wellesley College  
Notre Dame Community Housing  
University of New Haven  
Notre Dame Community Housing

#### Sports-Entertainment

Goldfish Swim Schools  
Burnt Tree Country Club  
Hillwood Country Club  
Kensington Country Club  
Sands Tower  
Newport National Golf Club  
Troubadour Fitness Center  
Starkville Country Club  
Wampanoag Country Club  
Red Rocks Visitor Center  
Universal Studios/Harry Potter  
Augusta National Golf Club  
Kansas State Casino  
Boca Beach Club  
Lancaster YMCA  
Columbia Country Club

#### Healthcare

MPGL Assisted Living  
Cedarfield Dental  
Sunrise Senior Living  
Livewell  
Macay Dermatology  
Family Focused Recovery  
Hudson Community Living  
Stoneridge Senior Living  
Covenant Place  
Oakmont of Carmichael  
Ashley Pond Care Center  
Paradigm Health  
Ravine at Settlers Point  
Jordan Valley Health Center  
Longhorn Village  
Skin Pharm  
Mendes Monteiro House

#### Office/Retail

Bass Pro Shops  
Athleta/Gap/Banana Republic  
Hallmark Financial  
CoVantage Credit Union  
Castle Rock Investments  
Edward Jones  
Flatirons Bank  
Netjets Citygate  
AIG National Hall  
Paradise Bank  
Nexus South  
United Bank

#### Government/Religious

St. Christopher Library  
COS Police Station  
New Boston Fire Department  
New York Society Library  
Stratford Town Hall  
Church of All Saints  
US Marshalls Office  
Clark County Courthouse  
Lowell City Hall  
Madison County Courthouse  
Grover Cleveland Birthplace

# Design that Complements the Planet

Our modern, domestic plants use lean manufacturing practices to make extremely efficient use of our raw materials. This minimizes waste and environmental impact.



TM9320 barn door in MDF with Brushed glass.

## 63% Recycled MDF Doors for Painted Applications

TruStile MDF doors are not only the highest quality paintable doors on the market, they are also the responsible environmental choice. We recycle MDF waste, donating it to agricultural partners who use it to create energy, reducing both landfill waste by 63% and waste pick ups, putting fewer trucks on the road. The green benefits of our MDF doors include:

- Certified by SCS Global Services to be constructed of 63% recycled content.
- Eligible for up to three LEED® credits
- Manufactured with low-emitting adhesives and coated with low-emitting primer.
- Standard MDF is low emitting, meeting CARB (California Air Resources Board) requirements.
- A no-added formaldehyde MDF option is also available.



MINIMUM 63% RECYCLED CONTENT  
PRE-CONSUMER

## Use TruStile on Your Next LEED® Certified Project

The LEED® (Leadership in Energy and Environmental Design) Green Building Rating System is a national standard developed and published by the U.S. Green Building Council (USGBC). Its purpose is to promote sustainable building that is environmentally responsible, profitable and healthy. TruStile doors also qualify for other green building rating systems. Contact us for details.

TruStile doors help achieve LEED v4.0 & v4.1 Building Design and Construction credits in the following categories for new commercial construction and major renovation projects:

### Material and Resources (MR) and Environmental Quality (EQ) Credits:

LEED credit	LEED criteria	TruStile MDF	TruStile Wood
MR Credit: Environmental Product Declarations (EPD)	Product-specific EPD with third-party certification (Type III), including external verification and external critical review	EPD Available	Not Eligible
MR Credit: Building Product Disclosure and Optimization – Sourcing of Raw Materials	Leadership Extraction Practices; Extended Producer Responsibility; Bio-based Materials; Material re-use; Recycled Content; FSC Certified Wood	Recycled Content	Not Eligible
EQ Credit: Low-Emitting Materials	Composite Wood Certified as ULEF or NAF per TSCA, Title VI, or CARB ATCM	ULEF & NAF Available	ULEF Available

TruStile doors help achieve LEED v4.1 Residential Single Family Home credits in the following categories:

### Material and Resources (MR) and Environmental Quality (EQ) Credits:

LEED credit	LEED criteria	TruStile MDF	TruStile Wood
MR Credit: Environmental Preferable Products	The product contains at least 25% post-consumer or 50% pre-consumer recycled content; Wood products must be FSC certified	SCS certified 63%	Not Eligible
EQ Credit: Low-Emitting Products	Composite wood certified as ULEF or NAF per TSCA, Title VI, or CARB ATCM	ULEF & NAF Available	ULEF Available

# Fire-Rated Doors

## Our Fire Doors Are as Stylish as They Are Safe

Designed to match non-rated doors, all TruStile fire doors feature full panel relief and are carefully engineered to complement our non-rated doors.

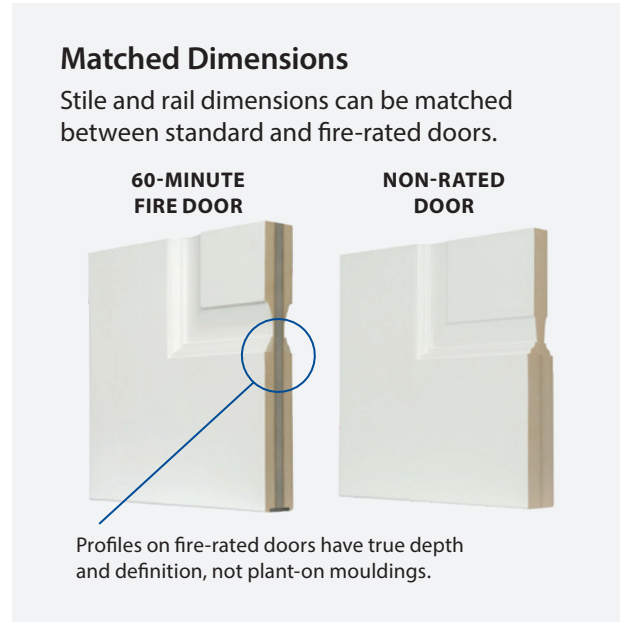

# Certified Fire Door Ratings

Throw away the preconception that you have limited design options for fire-rated openings. With most of our standard panel doors available in up to 90-minute ratings, you never have to sacrifice style when selecting 20- through 90-minute fire doors.

	20-minute MDF	20-minute Wood	45- and 60-minute MDF/Wood	90-minute MDF/Wood
Category	Category A Category B Neutral Pressure	Category A Category B Neutral Pressure	Category A Category B	Category A Category B
Thickness	1¾" minimum	1¾" minimum	1¾" minimum	1¾" minimum
Maximum width single	4'0"	4'0"	3'6"	3'6"
Maximum width pair	8'0"	8'0"	7'0"	7'0"
Maximum height	8'0"	8'0"	8'0"	8'0"
Maximum fire glass area	3,145 sq. inches	3,145 sq. inches	1,248 sq. inches – 45 minutes 1,216 sq. inches – 60 minutes	1,216 sq. inches
Standards	ASTM E-152, NFPA 80, NFPA 252, UL10B, UL10C			

Some door styles and panel profiles are not available in all fire ratings. Verify availability with TruStile.  
Some ratings require metal vision kits.



## Fire-Rated Glass Doors Also Available

Glass doors are the perfect solution for spaces where a fire door is required by code, but the look of a glass door is preferred. Select from over 120 fire-rated glass doors styles.

Refer to the fire-rated symbol  in the Door Collections section to see which glass door designs are available in 20-, 45-, 60- and 90-minute fire ratings.

Hose stream-approved glass can also be specified.

# Superior Sound Performance

Noise is an inescapable component of life in the modern home. Because of their weight, solid construction and high density, TruStile doors are the ideal solution to sound proofing a home.



Home theater featuring TS3070 in mahogany with custom porthole window.

Sound ratings are classified by an STC (sound transmission class) number that rates a material's ability to resist airborne sound. A higher STC rating blocks more noise from transmitting through a partition like a door. Standard TruStile MDF doors achieve up to a 34 STC rating, some 10- to 15-points better than typical hollow-core doors that achieve a "very poor" rating.

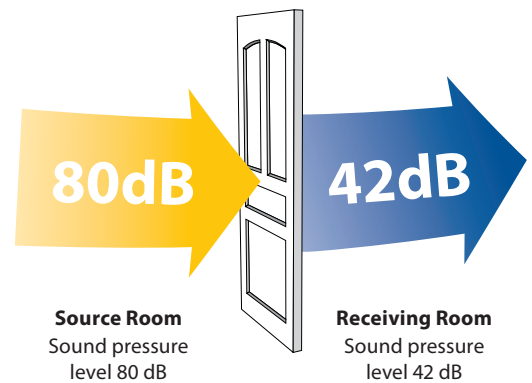

For openings requiring even better sound performance, TruStile can provide wood and MDF doors that achieve up to a 38 STC rating.

## Sound Transmission Class (STC) Ratings

TruStile has tested its sound doors in operable openings with Zero International sound gasketing packages.

STC Rating	Door Material	Door Styles	Door Thickness	Primary Seal	Secondary Seal	Threshold Saddle	Sweep
<b>Zero International hardware used</b>							
38	MDF	90-Minute Fire Door	1-3/4"	#188FS	#118B	Flat Surface	#369
34	MDF	TS5XXX through TS9XXX	1-3/4"	#475	#119	#564	#367
33	MDF	TS1XXX through TS4XXX	1-3/4"	#475	#119	#564	#367
32	MDF	TS5XXX through TS9XXX	1-3/4"	#475	None	#564	None
32	Wood	TS1XXX through TS4XXX	1-3/4"	#475	#119	#564	#367
30	MDF	TS1XXX through TS4XXX	1-3/4"	#475	None	#564	None
30	Wood	TS5XXX through TS9XXX	1-3/4"	#475	#119	#564	#367
30	Wood	TS1XXX through TS4XXX	1-3/4"	#475	None	#564	None

## Sound Transmission Class (STC) Examples

TruStile Advantage	STC	Performance	Description
	50 – 60	Excellent	Loud sounds heard faintly or not at all
	40 – 50	Very Good	Loud speech heard faintly
TruStile Door with Recommended Gasketing	35 – 40	Good	Loud speech heard but hardly intelligible
	30 – 35	Fair	Loud speech understood fairly well
	25 – 30	Poor	Normal speech understood easily and distinctly
Typical Hollow-Core Door	20 – 25	Very Poor	Low speech audible

# Design Tools

Design, Configure and Visualize Your Projects

## Door Visualizer

Imagine the possibilities for your home with the TruStile Door Visualizer. Customize your door's style and materials and see changes in real-time.

Share a link to your configured door with others or download a PDF tear sheet, high resolution image or 3D model for use in modeling programs.

[www.trustile.com/visualizer](http://www.trustile.com/visualizer)

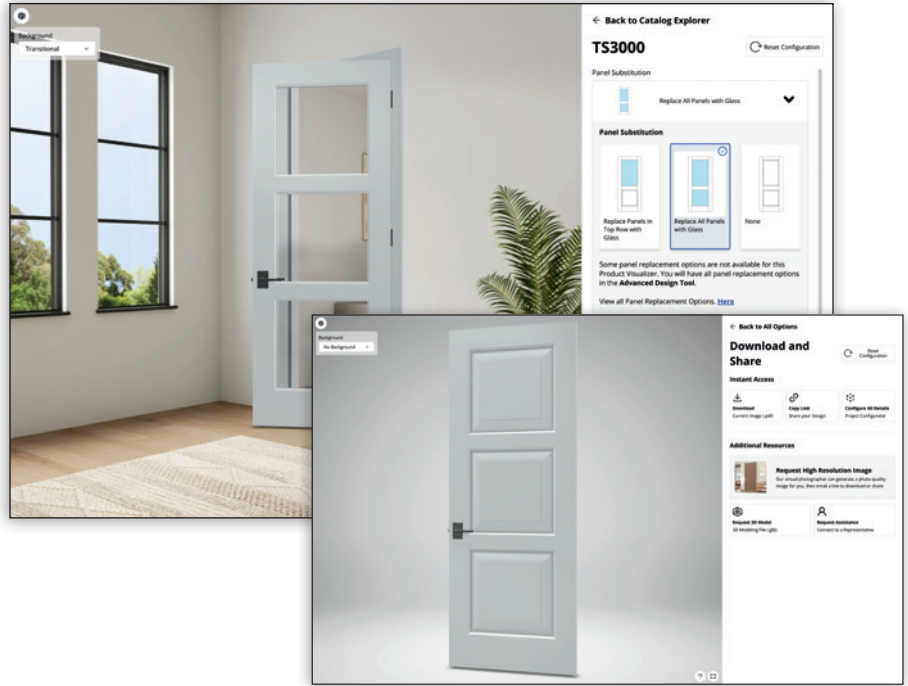

## Project Configurator

Design your own door package. Specify the height, width and location of all components within a door and save to a project.

Project Configurator projects can be exported as a door schedule that opens directly in Microsoft® Excel, as a PDF of drawings or CAD models to import directly into your plans.

[www.trustile.com/configurator](http://www.trustile.com/configurator)

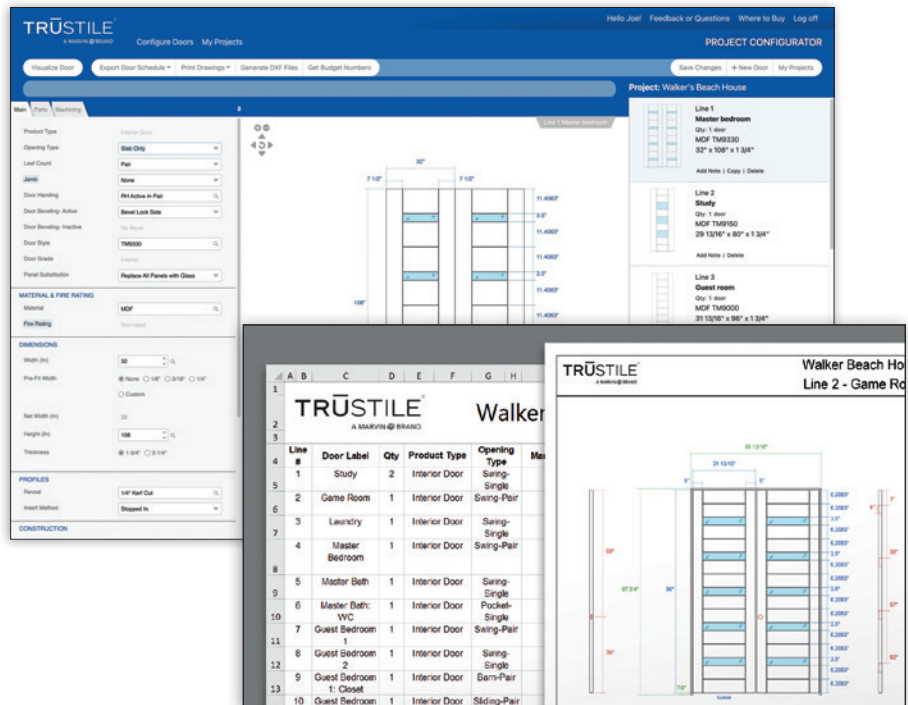



TM9440 pocket door in  
MDF with Shoji glass



Back cover: TM9420 in plain sawn white oak with Grey Mist finish and Capiz resin.

Front cover: TS5080 barn door in plain sawn white oak with Grey Mist finish, square stick sticking and Dash glass.

**TRUSTILE**<sup>®</sup>  
A MARVIN<sup>®</sup> BRAND



FOLLOW US



[www.trustile.com](http://www.trustile.com)

TruStile Doors is not responsible for errors or omissions in this catalog. Confirm information with your sales representative before ordering.

Copyright © 2026, TruStile Doors, LLC. All rights reserved. Effective February 18, 2026.

**TRUSTILE DOORS, LLC**

1111 E. 71st Avenue  
Denver, CO 80229

888.286.3931